

Reinforced End Tab Folders

MRS10 & MRS20 | CRS10 & CRS15

Comparable to Tab, Smead, Barkley

- Overall Size: 9-1/2" H x 12-1/4" W
- Tab Length: 8-1/2"
- Front Size: 9-1/2" H x 11-3/4" W
- Scored for 3/4" Expansion
- Undercut to: 11-3/8"
- 10 Scored Tick Marks

Item #	Paper Weight	Fastener Position	Qty per box	Qty per Ctn	Lb / 1,000
MRS10	11pt	None	100	500	90
MRS1021	11pt	1	50	250	95
MRS10213	11pt	1 & 3	50	250	100
MRS20	14pt	None	50	250	110
MRS2021	14pt	1	50	250	115
MRS20213	14pt	1 & 3	50	250	120

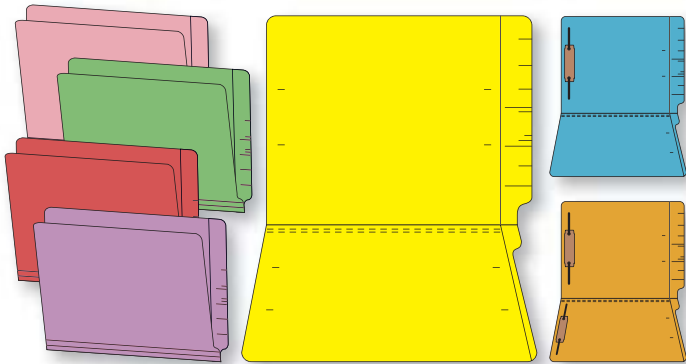
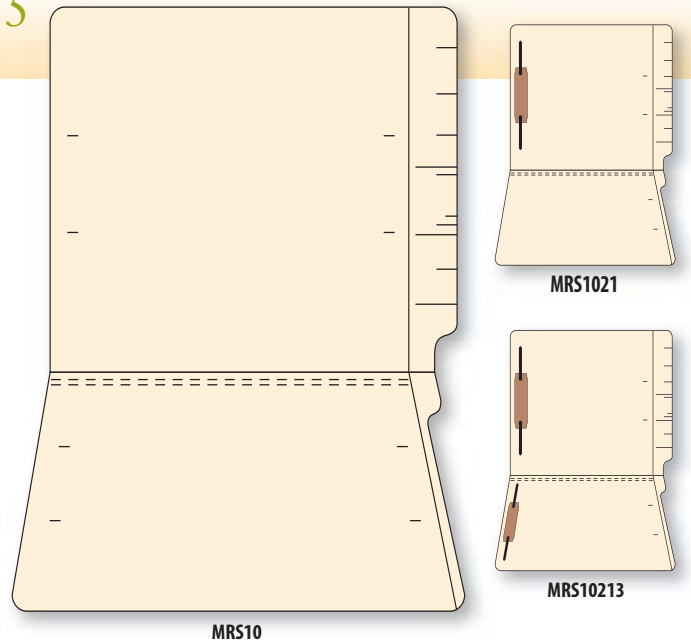

Item #	Paper Weight	Fastener Position	Qty per box	Qty per Ctn	Lb / 1,000
CRS10 + color	11pt	None	100	500	95
CRS1021 + color	11pt	1	50	250	100
CRS10213 + color	11pt	1 & 3	50	250	105
CRS15 + color	15pt	None	50	250	110
CRS1521 + color	15pt	1	50	250	115
CRS15213 + color	15pt	1 & 3	50	250	120

18 Available 11pt Colors								
red	yellow	pink	green	white	brown	blue	orange	tan
gray	dark orange	dark gray	dark blue	dark green	purple	canary	gldnrd	lavnder

11 Available 15pt Colors					
red	canary	pink	green	white	lavnder
gray	dark orange	dark gray	dark blue	gldnrd	

Fastener Postions

RIGHT HAND TAB FOLDER

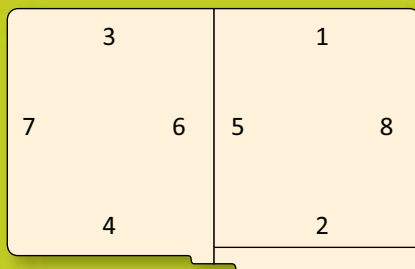

Fasteners or clips can be ordered in any position. Please refer to the charts for clip and fastener position numbers. When ordering, state the folder item number, size of the fastener, type of the fastener and the desired position(s).

Example: MRS10, 2" fastener, position #1 and #3.

Pay special attention to fastener postions when ordering a left-hand tab folder or pocket folders.

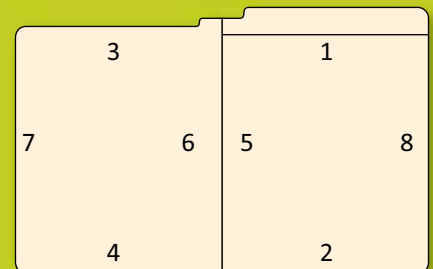

LEFT HAND TAB FOLDER

Reinforced End Tab Folders

JRET11 & JRET14

Comparable to Jeter

Overall Size: 9-1/2" H x 12-1/4" W, Front Size: 9-1/2" H x 11-3/4" W,
Undercut to: 11-3/8", Tab Length: 8-1/2", Scored for 3/4" expansion

Item #	Paper Weight	Fastener Position	Qty per box	Qty per Ctn	Lb / 1,000
JRET11	11pt	None	100	500	90
JRET1121	11pt	1	50	250	95
JRET11213	11pt	1 & 3	50	250	100
JRET14	14pt	None	50	250	110
JRET1421	14pt	1	50	250	115
JRET14213	14pt	1 & 3	50	250	120

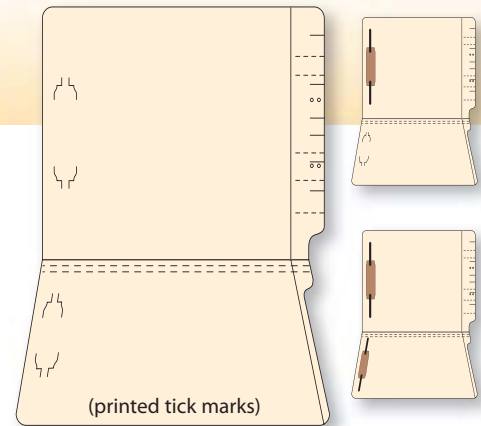

BET11 & BET14

Comparable to Barkley

Overall Size: 9-1/2" H x 12-1/4" W, Front Size: 9-1/2" H x 11-3/4" W,
Undercut to: 11-3/8" Tab Length: 8-1/2", Scored for 3/4" expansion

Item #	Paper Weight	Fastener Position	Qty per box	Qty per Ctn	Lb / 1,000
BET11	11pt	None	100	500	90
BET1121	11pt	1	50	250	95
BET11213	11pt	1 & 3	50	250	100
BET14	14pt	None	50	250	110
BET1421	14pt	1	50	250	115
BET14213	14pt	1 & 3	50	250	120

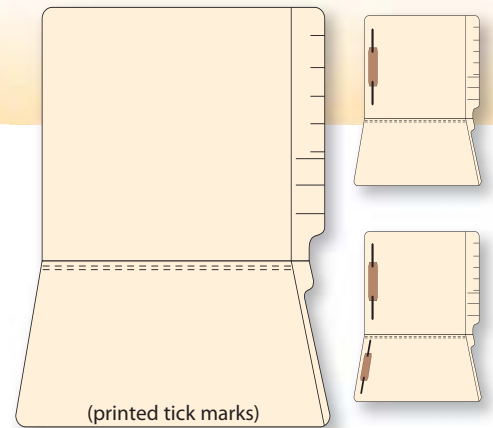

MR11 & MR15

Comparable to Jeter

Overall Size: 9-1/2" H x 12-1/4" W, Front Size: 9-1/2" H x 11-3/8" W,
Tab Length: 9-3/8", Scored for 3/4" expansion

Item #	Paper Weight	Fastener Position	Qty per box	Qty per Ctn	Lb / 1,000
MR11	11pt	None	100	500	95
MR1121	11pt	1	50	250	100
MR11213	11pt	1 & 3	50	250	105
MR15	14pt	None	50	250	110
MR1521	14pt	1	50	250	115
MR15213	14pt	1 & 3	50	250	120

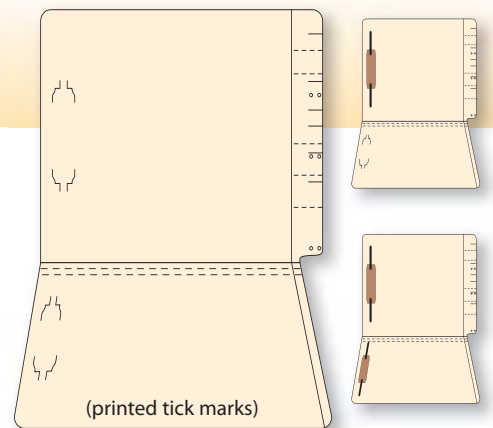

MAM11 & MAM15

Comparable to Ames

Overall Size: 9-1/2" H x 12-1/4" W, Front Size: 9-1/2" H x 11-3/8" W,
Tab Length: 9", Scored for 1-3/8" expansion, Interlocking reinforced top and end tab

Item #	Paper Weight	Fastener Position	Qty per box	Qty per Ctn	Lb / 1,000
MAM11	11pt	None	100	500	105
MAM1121	11pt	1	50	250	110
MAM11213	11pt	1 & 3	50	250	115
MAM15	14pt	None	50	250	130
MAM1521	14pt	1	50	250	135
MAM15213	14pt	1 & 3	50	250	140

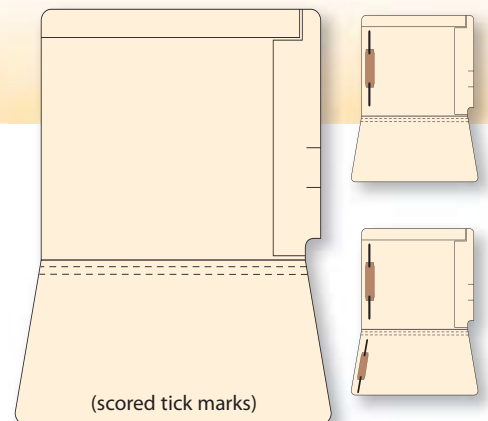

Reinforced End Tab Folders

M11SH

Comparable to Barkley

- Overall Size: 9-1/2" H x 12" W
- Front Size: 9-1/2" H x 11-1/4" W
- Tab Length: 8-1/2"
- Scored for 3/4" expansion
- Reinforced top and end tab

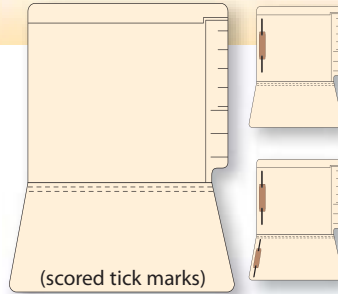

Item #	Paper Weight	Fastener Position	Qty per box	Qty per Ctn	Lb / 1,000
M11SH	11pt	None	100	500	105
M11SH21	11pt	1	50	250	110
M11SH213	11pt	1 & 3	50	250	115

MRST15

Comparable to Barkley

- Overall Size: 9-1/2" H x 12-1/4" W
- Front Size: 9-1/2" H x 11-3/4" W
- Undercut to: 11 3/8"
- Tab Length: 9-3/8"
- Scored for 1-3/8" expansion
- Reinforced top and end tab

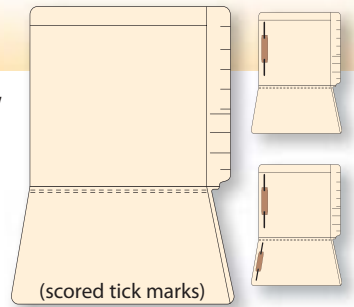

Item #	Paper Weight	Fastener Position	Qty per box	Qty per Ctn	Lb / 1,000
MRST15	14pt	None	50	250	130
MRST1521	14pt	1	50	250	135
MRST15213	14pt	1 & 3	50	250	140

MW15

2" W-Fold Expansion Folder
Comparable to Ames

- Overall Size: 9-1/2" H x 12-1/4" W
- Front Size: 9-1/2" H x 11-3/8" W
- Tab Length: 9-3/8"
- Scored for 2" W-fold expansion
- Interlocking reinforced top and end tab
- Ships flat

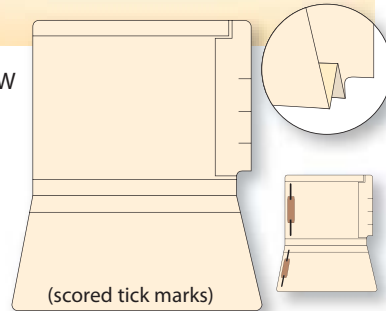

Item #	Paper Weight	Fastener Position	Qty per box	Qty per Ctn	Lb / 1,000
MW15	14pt	None	200		95
MW1521	14pt	1	150		100
MW15213	14pt	1 & 3	150		105

MSF11

Comparable to Col'R'Tab, GBS/VRE

- Overall Size: 9-1/2" H x 12" W
- Front Size: 9-1/8" H x 11-1/2" W
- Top Undercut to: 8-3/4"
- Side Undercut to: 11-1/4"
- Tab Length (top & end): 8-5/8"
- Scored for 3/4" expansion
- Reinforced top and end tab

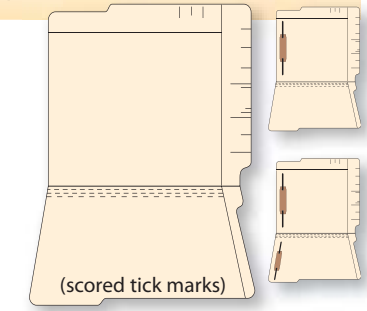

Item #	Paper Weight	Fastener Position	Qty per box	Qty per Ctn	Lb / 1,000
MSF11	11pt	None	100	500	100
MSF1121	11pt	1	50	250	105
MSF11213	11pt	1 & 3	50	250	110

M11BC

Border Printed Folder

- Overall Size: 9-1/2" H x 12-1/4" W
- Front: 9-1/2" H x 11-3/4" W
- Undercut to: 11-3/8"
- Tab Length: 8-1/2"
- Scored for 3/4" expansion

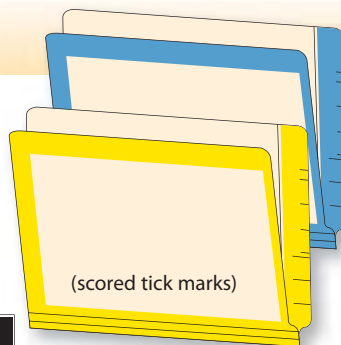

M11BC Colors				
red	yellow	pink	green	brown
gray	orange	tan	blue	violet

Item #	Paper Weight	Fastener Position	Qty per box	Qty per Ctn	Lb / 1,000
M11BC + color	11pt	None	100	500	90
M11BC21 + color	11pt	1	50	250	95
M11BC213 + color	11pt	1 & 3	50	250	100

MRS20ETMY

Mylar Reinforced End Tab

- 14pt letter size manila double ply end tab folder.
- Mylar reinforced front, back, and end tab is perfect for heavy use.

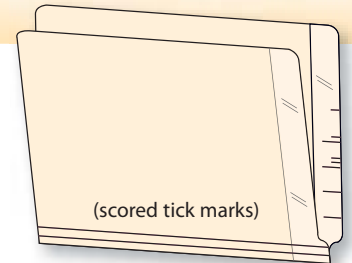

Item #	Fastener Position	Qty per box	Qty per Ctn	Lb / 1,000
MRS20ETMY	None	50	250	110
MRS20ETMY21	1	50	250	115
MRS20ETMY213	1 & 3	50	250	120

Single Ply End Tab Folders

MS100 & MS200

Comparable to Tab, Smead, Barkley

- Overall Size: 9-1/2" H x 12-1/4" W
- Front Size: 9-1/2" H x 11-3/4" W
- Undercut to: 11-3/8"
- Tab Length: 8-1/2"
- Scored for 3/4" expansion
- 11 or 14pt

Item #	Paper Weight	Fastener Position	Qty per box	Qty per Ctn	Lb / 1,000
MS100	11pt	None	100	500	75
MS10021	11pt	1	50	250	80
MS100213	11pt	1 & 3	50	250	85
MS200	14pt	None	50	250	95
MS20021	14pt	1	50	250	100
MS200213	14pt	1 & 3	50	250	105

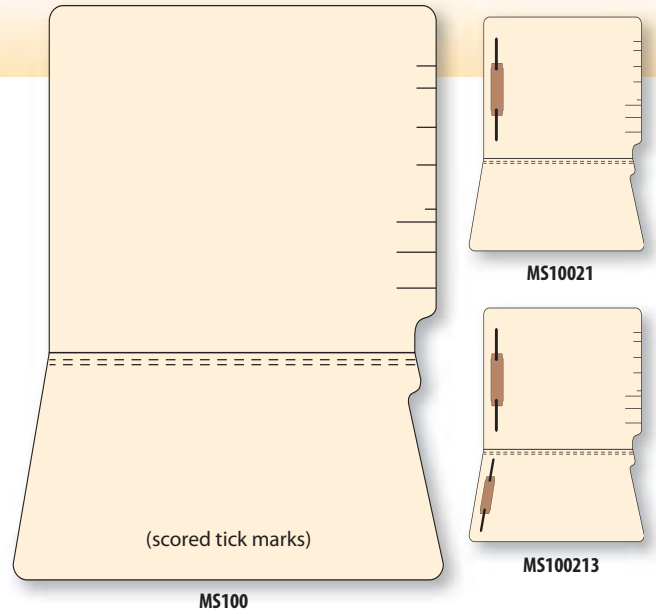

JET14

Comparable to Jeter

- Overall Size: 9-1/2" H x 12-1/4" W
- Front Size: 9-1/2" H x 11-3/4" W
- Undercut to: 11-3/8"
- Tab Length: 8-3/8"
- Scored for 3/4" expansion

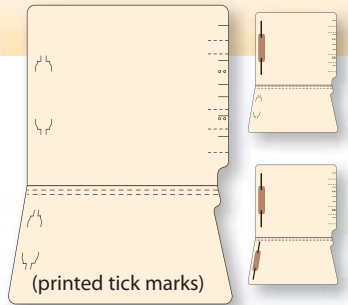

Item #	Paper Weight	Fastener Position	Qty per box	Qty per Ctn	Lb / 1,000
JET14	14pt	None	100	500	95
JET1421	14pt	1	50	250	100
JET14213	14pt	1 & 3	50	250	105

PETR14

Comparable to PMA

- Overall Size: 9-1/2" H x 12-1/4" W
- Front Size: 9-1/2" H x 11-3/4" W
- Tab Length: 9"
- Scored for 3/4" expansion

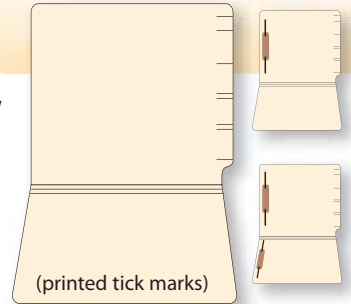

Item #	Paper Weight	Fastener Position	Qty per box	Qty per Ctn	Lb / 1,000
PETR14	14pt	None	100	500	95
PETR1421	14pt	1	50	250	100
PETR14213	14pt	1 & 3	50	250	105

SS18 & SS18MMY

18pt Single Ply

- Overall Size: 9-1/2" H x 12-1/4" W
- Front Size: 9-1/2" H x 11-3/4" W
- Undercut to: 11-3/8"
- Tab Length: 8-1/2"
- Scored for 3/4" expansion
- Optional Mylar reinforced spine
- Packed 50/box

Item #	Paper Weight	Fastener Position	Lb / 1,000
SS18M	18pt	None	150
SS18M21	18pt	1	155
SS18M213	18pt	1 & 3	160
SS18MMY	18pt	None	150
SS18MMY21	18pt	1	155
SS18MMY213	18pt	1 & 3	160

items MY include Mylar reinforced spine

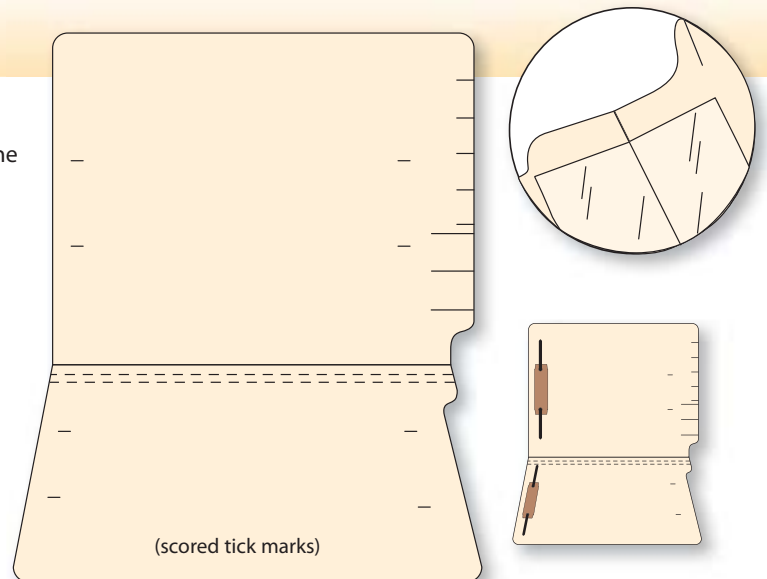

Single Ply End Tab Folders

VR11 & VR15

Comparable to GBS / VRE

- Overall Size: 9-1/2" H x 12-1/4" W
- Front Size: 9-1/2" H x 11-3/8" W
- Printed tick marks on back of folder
- Tab Length: 8-7/8"
- Scored for 3/4" expansion
- 11 or 14pt

Item #	Paper Weight	Fastener Position	Qty per box	Qty per Ctn	Lb / 1,000
VR11	11pt	None	100	500	75
VR1121	11pt	1	50	250	80
VR11213	11pt	1 & 3	50	250	85
VR15	14pt	None	50	250	95
VR1521	14pt	1	50	250	100
VR15213	14pt	1 & 3	50	250	105



MS15

Comparable to Jeter

- Overall Size: 9-1/2" H x 12-1/4" W
- Front Size: 9-1/2" H x 11-3/8" W
- Tab Length: 9-3/8"
- Scored for 3/4" expansion

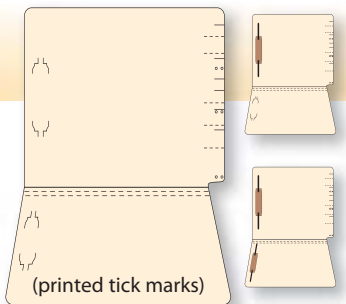

Item #	Paper Weight	Fastener Position	Qty per box	Qty per Ctn	Lb / 1,000
MS15	14pt	None	100	500	95
MS1521	14pt	1	50	250	100
MS15213	14pt	1 & 3	50	250	105

PETL14

14pt Single Ply End Tab

- Overall Size: 9-1/2" H x 12-1/4" W
- Front Size: 9-1/2" H x 11-3/4" W
- Tab Length: 9"
- Scored for 3/4" expansion

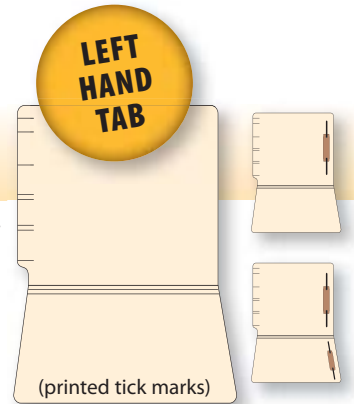

Item #	Paper Weight	Fastener Position	Qty per box	Qty per Ctn	Lb / 1,000
PETL	14pt	None	100	500	95
PETL22	14pt	2	50	250	100
PETL224	14pt	2 & 4	50	250	105

RIGHT HAND TAB FOLDER

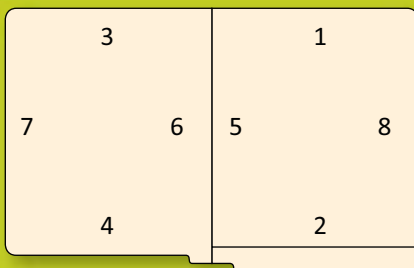

Fastener Postions

Fasteners or clips can be ordered in any position. Please refer to the charts for clip and fastener position numbers. When ordering, state the folder item number, size of the fastener, type of the fastener and the desired position(s).

Example: *MRS10, 2" fastener, position #1 and #3.*

Pay special attention to fastener positions when ordering a left-hand tab folder or pocket folders.

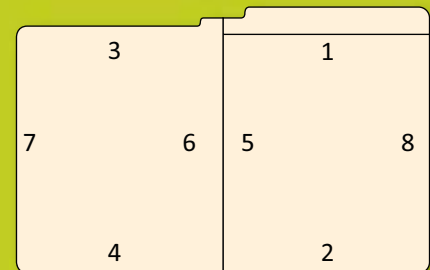

LEFT HAND TAB FOLDER

Top Tab Folders

MR50

Comparable to Smead, Barkley

Also Available in Colors page 17

- Overall Size: 9-1/2" H x 11-3/4" W
- Front Size: 8-7/8" H x 11-3/4" W
- Tab Length: 11-3/4"
- Scored for 3/4" expansion
- Straight Cut reinforced top tab

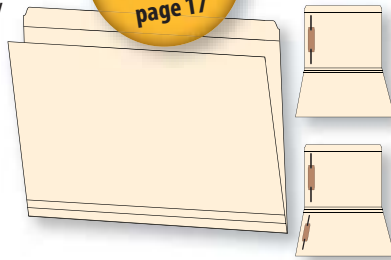

Item #	Paper Weight	Fastener Position	Qty per box	Qty per Ctn	Lb / 1,000
MR50	11pt	None	100	500	90
MR5021	11pt	1	50	250	95
MR50213	11pt	1 & 3	50	250	100

M11TT

- Overall Size: 9-15/16" H x 11-3/4" W
- Front Size: 8-7/8" H x 11-3/4" H
- Tab Length: 8"
- Scored for 3/4" expansion
- Reinforced top tab

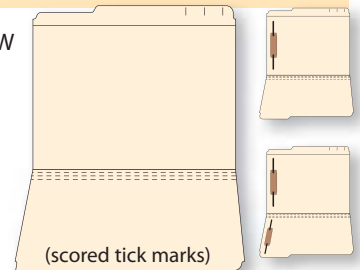

Item #	Paper Weight	Fastener Position	Qty per box	Qty per Ctn	Lb / 1,000
M11TT	11pt	None	100	500	90
M11TT21	11pt	1	50	250	95
M11TT213	11pt	1 & 3	50	250	100

SM11

Comparable to Smead

- Overall Size: 9-1/2" H x 11-3/4" W
- Front Size: 9" H x 11-3/4"
- Full top tab
- Scored for 3/4" expansion
- Full reinforced right end
- 0-9 scale printed in two locations, top & right side on outside back panel

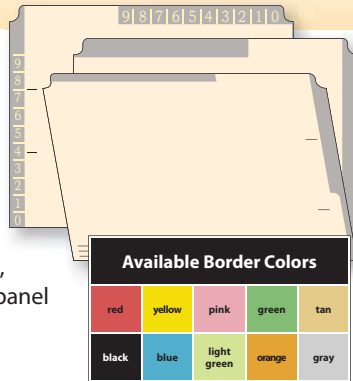

Available Border Colors				
red	yellow	pink	green	tan
black	blue	light green	orange	gray

Item #	Paper Weight	Fastener Position	Qty per box	Lb / 1,000
SM11 + color	11pt	None	100	90
SM1121 + color	11pt	1	50	95
SM11213 + color	11pt	1 & 3	50	100

M9518

Comparable to Smead, Barkley

- Overall Size: 9-1/2" X 11-3/4"
- Front Size: 8-7/8" X 11-3/4"
- Tab Length: 3-3/4"
- Scored for 3/4" expansion
- Packed 1 tab position per box
- Reinforced 1/3 cut top tab. Choose left, center or right position

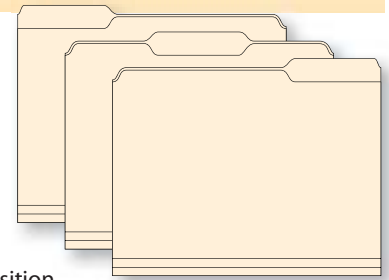

Item #	Paper Weight	Fastener Position	Qty per box	Lb / 1,000
M9518 + tab position	11pt	None	100	90
M951821 + tab position	11pt	1	50	95
M9518213 + tab position	11pt	1 & 3	50	100

TTC11

Comparable to Smead, Barkley

Similar in construction to the M9518, this 11pt 1/3rd cut top-tab is available in manila and 10 pulp-dyed colors. Assorted tab positions packed per box.

- Overall Size: 9-1/2" X 11-3/4"
- Front Size: 8-7/8" X 11-3/4"
- Tab Length: 3-3/4"
- Scored for 3/4" expansion
- Reinforced 1/3 cut top tab.
- Assorted tabs packed per box
- Specify color when ordering



TTC11 Colors	
manila	red
pink	canary
dark blue	dark orange
gldnrd	white
gray	lavnder
green	

Item #	Paper Weight	Fastener Position	Qty per box	Qty per Ctn	Lb / 1,000
TTC11	11pt	None	100	500	95
TTC1121	11pt	1	50	250	100
TTC11213	11pt	1 & 3	50	250	105

Pocket Folders

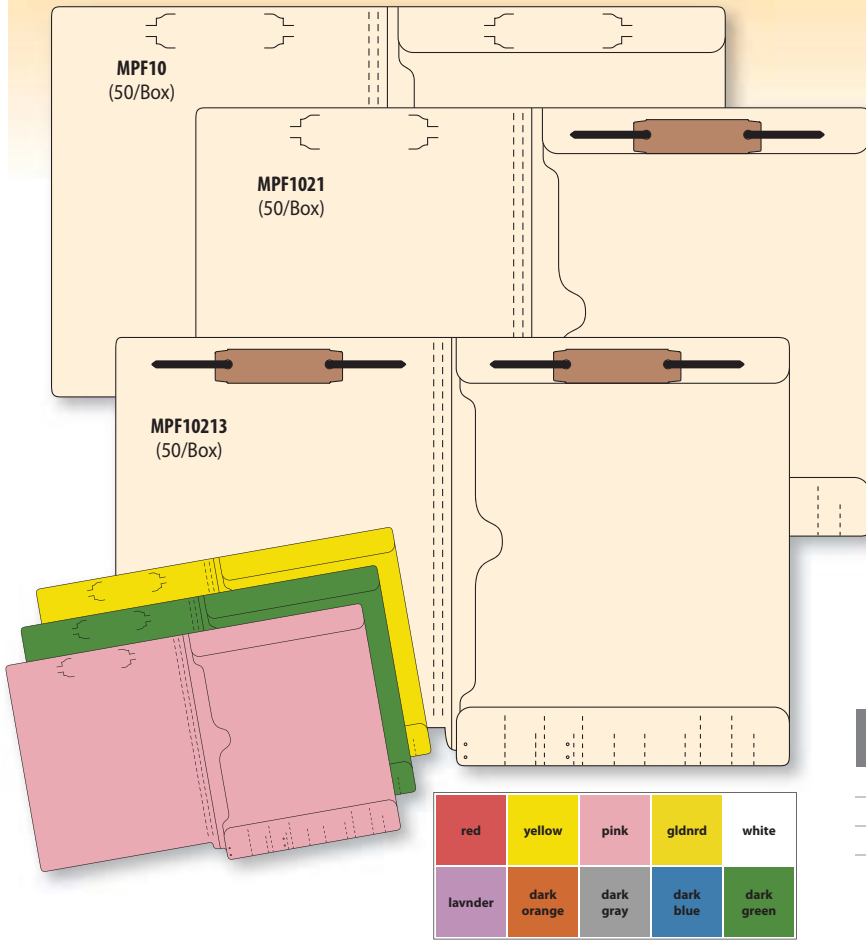

Structurally designed pocket folders and folders with installed pockets have become essential because of the broad assortment of documents and document sizes being stored today. Choose from a large selection of multi-functional pocket folders to meet your particular needs.

MPF10 Comparable to Barkley

Constructed from 11pt manila or colored stock with an integral side seam pocket sealed on three sides. Full size pocket is 9-3/8" H x 12-1/4" W and has printed label placement marks. Overall size is 9-1/2" H x 12-1/4" W.

Item #	Paper Weight	Fastener Position	Qty per box	Qty per Ctn	Lb / 1,000
MPF10	11pt	None	50	250	130
MPF1021	11pt	1	50	250	135
MPF10213	11pt	1 & 3	50	250	140

Specify color when ordering.

MRSP10 & MRSP14

Left Hand Single-Pocket Folder

- 11 & 14pt Manila and Colors
- 9-1/2" H x 12-1/4" W; pocket 5-3/4" D
- 8 scored tick marks

Item #	Paper Weight	Fastener Position	Qty per box	Qty per Ctn	Lb / 1,000
MRSP10	11pt	None	50	250	110
MRSP1021	11pt	1	50	250	115
MRSP14	14pt	None	50	250	150
MRSP1421	14pt	1	50	250	155

Specify color when ordering.

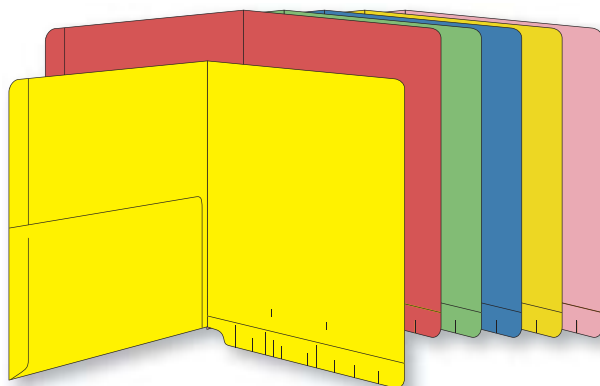
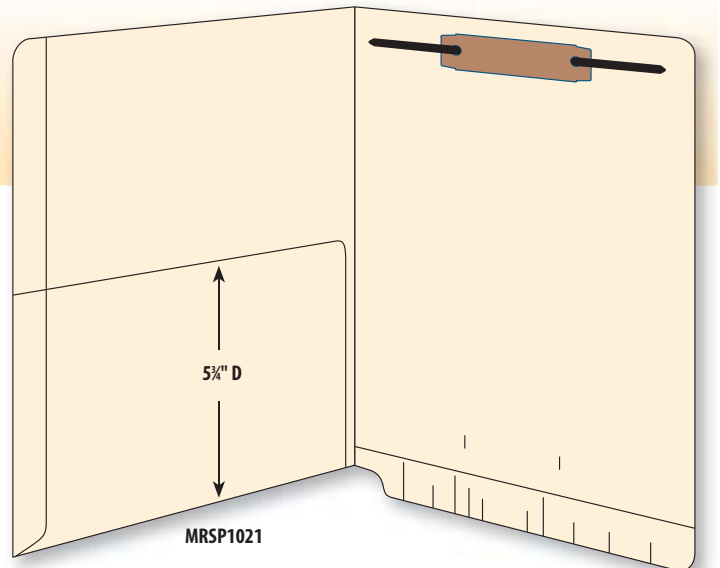

Available 11pt & 14pt Colors		
red	canary	pink
gldnrd	green	dark blue

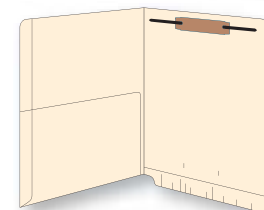

MRSPDF10
available 9" H front manila only (50/Box)

Pocket Folders

MPFA10

Full Cut-Corner Pocket Folder

9-1/2" H x 12-1/4" W; pocket 9-3/8" H x 11-5/8" W

11pt manila stock, double ply tab with printed label placement marks.

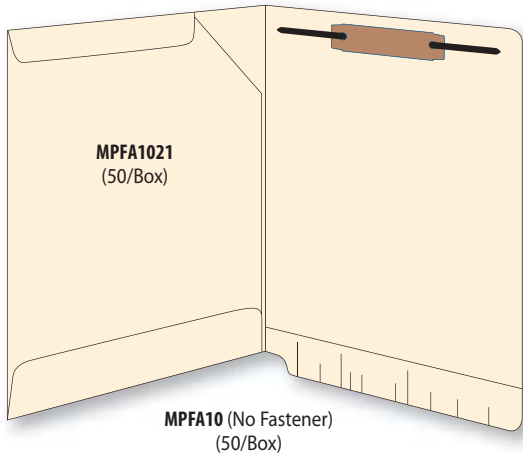

MRSPR11

Right Hand Single-Pocket Folder

9-1/2" H x 12-1/4" W; pocket 5-3/4" H x 9" W

11pt manila stock, double ply tab with scored label placement marks.

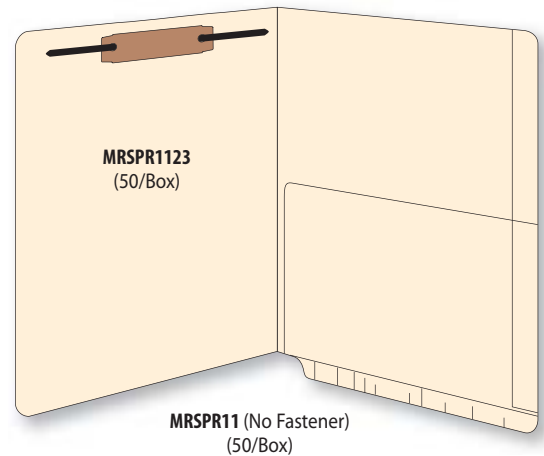

Pre-assembled Pocket Folders

9-1/2" H x 12-1/4" W

Base folder is an 11pt manila MRS10 with scored label placement marks.

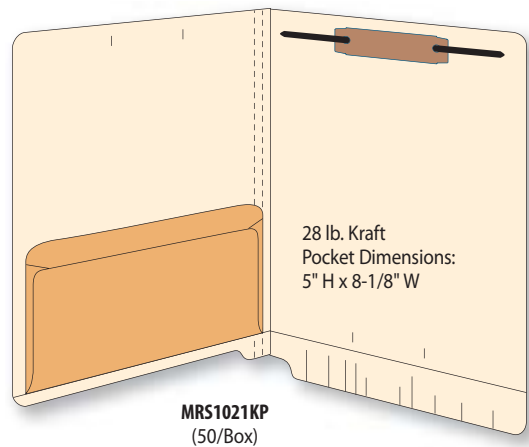
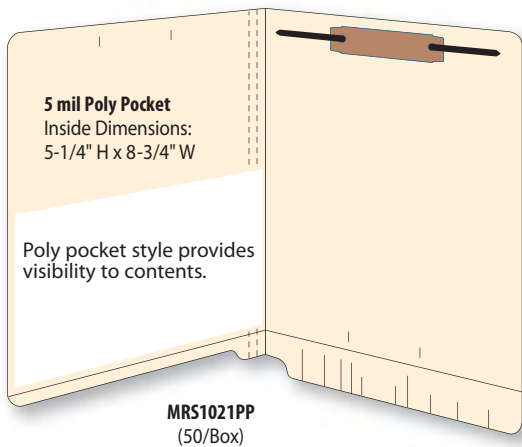
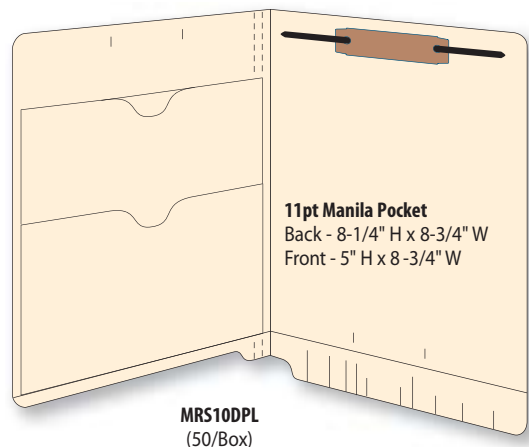
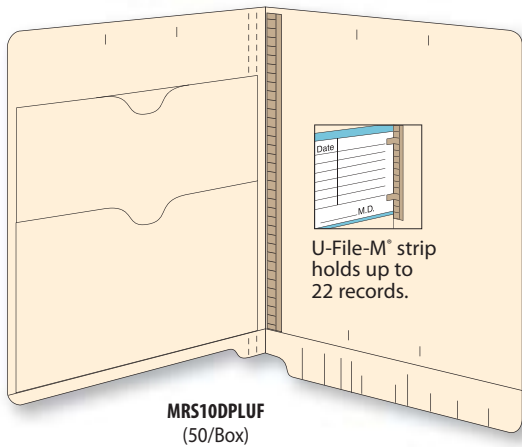

MDPOUT

Double Outside-Pocket Folders
9-1/2" H x 12-1/4" W

11pt manila construction; Folder design is perfect for dental practices to hold panorex x-rays, photos, etc.

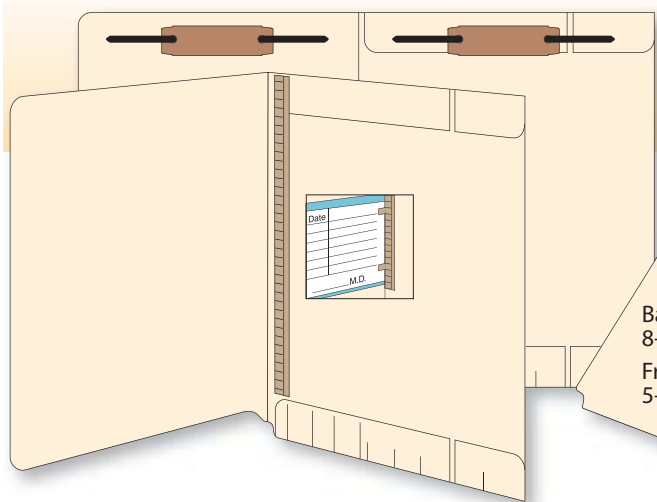

Back Pocket
8-3/4" H x 12-1/4" W
Front Pocket
5-1/2" H x 12-1/4" W

MDPOUT - (50/Box)
Double pocket folder with no additional fasteners installed

MDPOUTUF - (50/Box)
Includes a U-File-M® strip in position #5; holds up to 22 records

MDPOUT213 - (50/Box)
2" Bonded fasteners in positions 1 & 3 for maximum storage capacity

MTTPK

Right Hand Single-Pocket Folder

9-1/2" H x 12-1/4" W; pocket 5-3/4" H x 9" W

11pt manila stock, double ply tab with scored label placement marks.

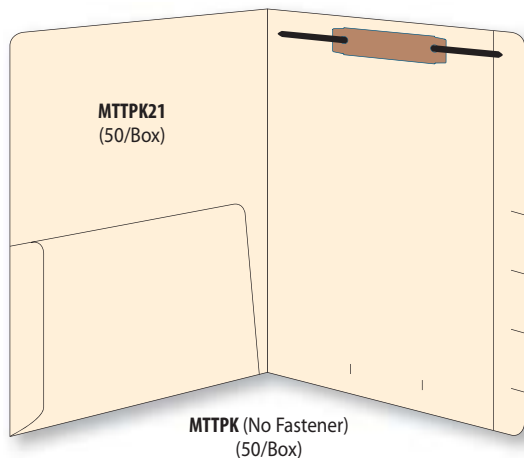

MTTPK21
(50/Box)

MTTPK (No Fastener)
(50/Box)

Pocket Folders with Strength & Capacity

MPFO14213

Full Size Pocket Folder — 9-1/2" H x 12-1/4" W

Constructed from a 14pt (MS15) folder with an 11pt (FP12) pocket laminated to the inside provides maximum durability. Dimensions of pocket are 9-3/8" H x 12-1/4" W

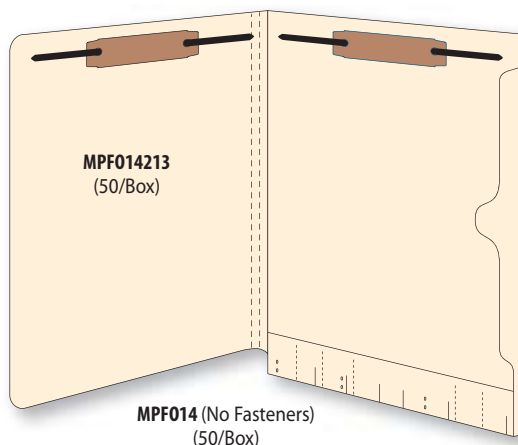

MPFO14213
(50/Box)

MPFO14 (No Fasteners)
(50/Box)

MPFDP10

Twin Pocket Folder — 9-1/2" H x 12-1/4" W

Constructed from 11pt manila stock, folder has two pockets for storage of panorex x-rays, photos, etc.

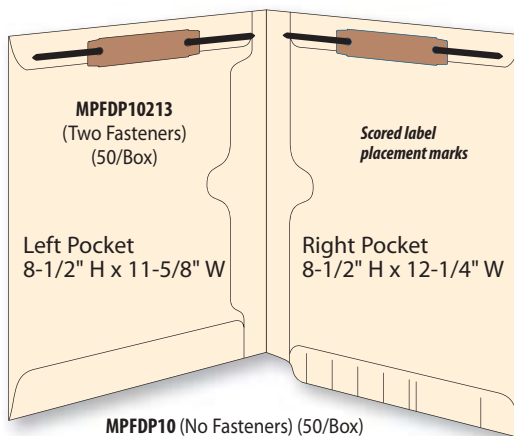

MPFDP10213
(Two Fasteners)
(50/Box)

Scored label placement marks

Left Pocket
8-1/2" H x 11-5/8" W

Right Pocket
8-1/2" H x 12-1/4" W

MPFDP10 (No Fasteners) (50/Box)

**stand alone
pocket
accessories
page 25-26**



Divider / Classification Folders

Folders with Manila Dividers

9-1/2" H x 12-1/4" W

Assembled from stock components, these folders feature an 11pt or 14pt reinforced folder with one or two 11pt manila dividers and 2" bonded fasteners. (25/box 125/ctn)

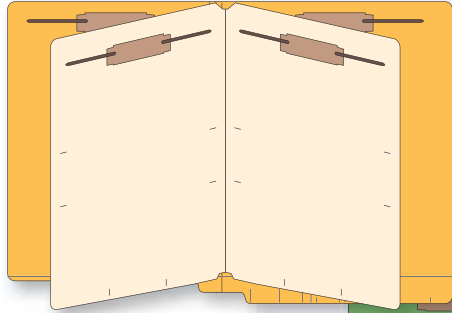

CRS10D2

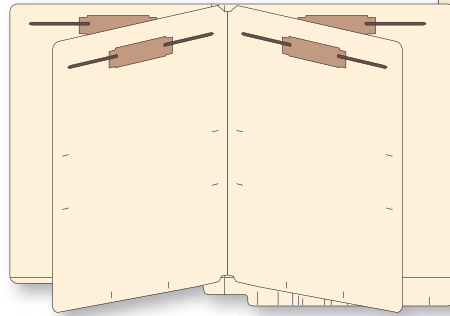

MRS20D2

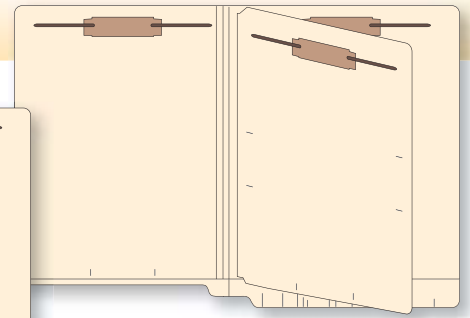

MRS10D1

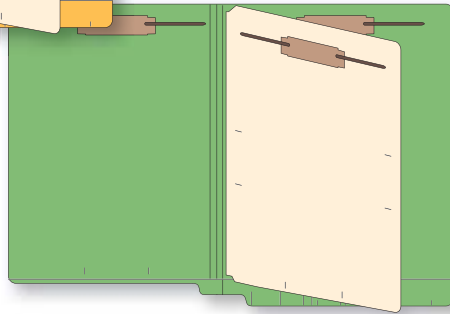

CRS10D1

Divider folders allow the contents of each chart to be easily categorized and sub-divided.



Item #	Paper Weight	Fasteners	Qty per box	Lb / 1,000
MRS10D1	11pt	4 total	25	150
MRS10D2	11pt	6 total	25	200
MRS20D1	14pt	4 total	25	195
MRS20D2	14pt	6 total	25	245
CRS10D1 + color	11pt	4 total	25	150
CRS10D2 + color	11pt	6 total	25	200
MRS10D1*	11pt	4 total	25	150
MRS10D2*	11pt	6 total	25	200

* 9" high front panel

Specify color when ordering

18PT & 20PT Folders with Kraft Dividers

9-1/2" H x 12-1/4" W

Assembled from stock components, these folders feature a heavy weight folder with one or two 11pt brown kraft dividers.

All styles feature a 2" Tyvek expansion.

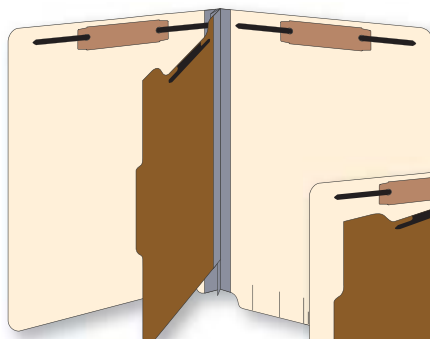
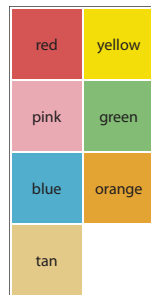

18PT1DM
18pt Manila

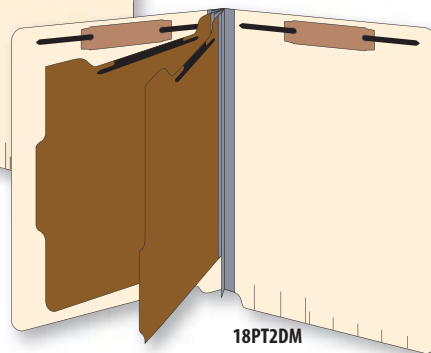

18PT2DM
18pt Manila

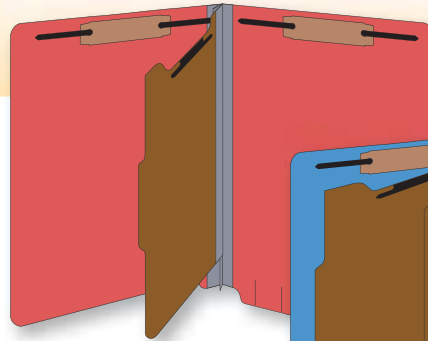

20PT1DR
20pt Colored Stock

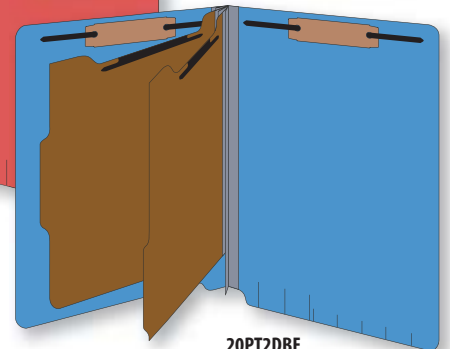

20PT2DBE
20pt Colored Stock

Item #	Expansion	Paper Weight	Qty per box	Lb / 1,000
18PT1DM	2" gray	18pt	15	185
18PT2DM	2" gray	18pt	10	235
20PT1D + color	2" gray	20pt	15	200
20PT2D + color	2" gray	20pt	10	250

Specify color when ordering

14PT Folders with Manila Dividers

9-1/2" H x 12-1/4" W

Construction features 14pt outer folder with double-back 28pt thick dividers, 2" bonded fasteners and a 2" poly reinforced W-fold expansion.

Extra heavy dividers with 2" bonded fasteners provide the necessary rigidity to hold maximum volume of documents. Folders will not sag or bow on the shelf.

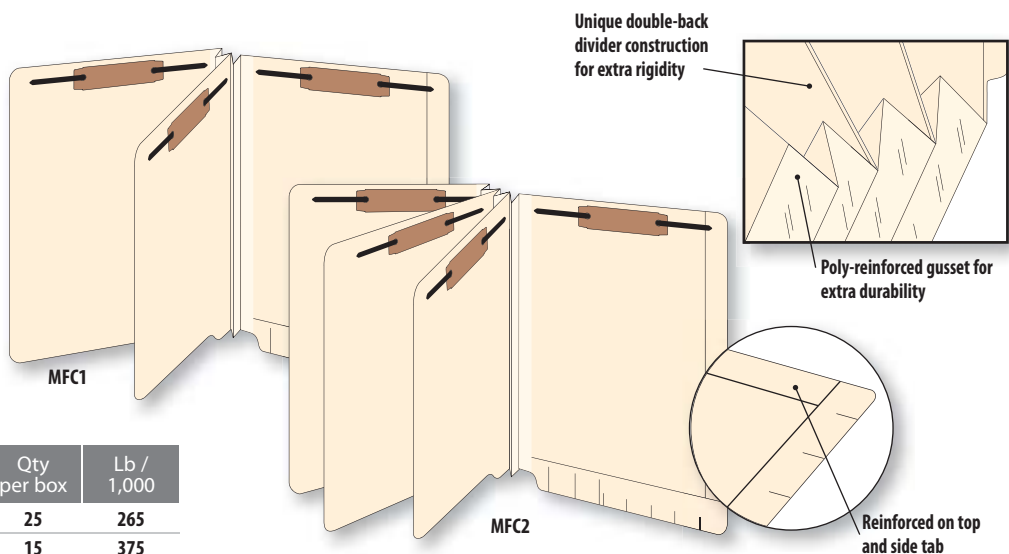

Item #	Expansion	Fasteners	Qty per box	Lb / 1,000
MFC1	2" W-fold	4 total	25	265
MFC2	3" W-fold	6 total	15	375

18PT Folders with Manila Dividers

9-1/2" H x 12-1/4" W

Construction features 18pt single ply folder with Tyvek® gusset. Because of the flexible Tyvek® gusset, these folders will not bulk-up on the shelf and take up valuable space.

Tyvek® spine provides a flexible gusset and long life for active records.

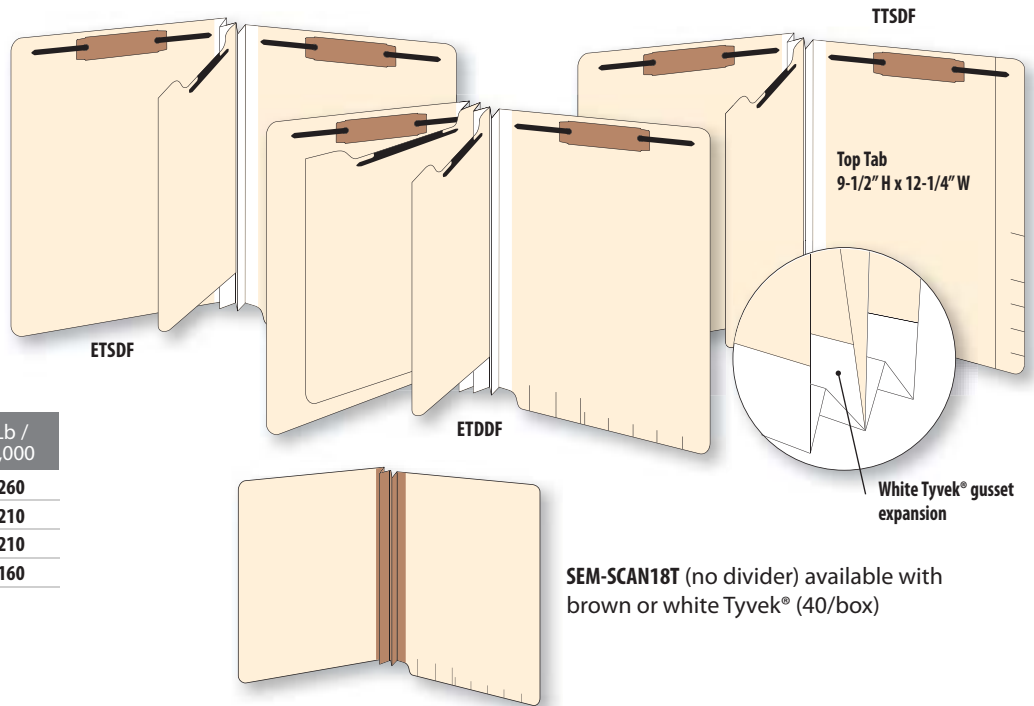

Item #	Expansion	Qty per box	Lb / 1,000
ETSDF	1-1/2"	25	260
ETDDF	1-1/2"	15	210
TTSDF	2"	20	210
SEM-SCAN18T	1-1/2"	40	160

SEM-SCAN18T (no divider) available with brown or white Tyvek® (40/box)

Pocket Folders with Manila Dividers

DVP113 – Unique construction and features, this 11pt folder has full outside pocket that is 12-1/4" W x 8-1/4" D and will accommodate Panorex x-rays without having to trim them. Scored label placement lines.

MRSP1421D1 – Base single pocket folder is 14pt thick with an 11pt divider installed in position #5.

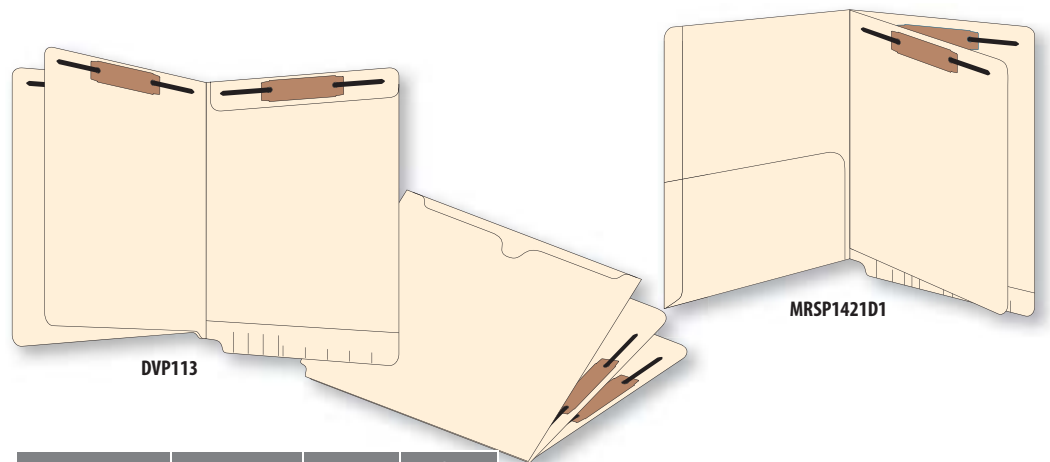

Item #	Fasteners	Qty per box	Lb / 1,000
DVP113	4 total	25	205
MRSP1421D1	3 total	25	200

File Pockets

AC11 & AC14 End-Tab File Pockets

9-1/2" H x 12-1/4" W – 11pt & 14pt Manila and 11pt Colors

Diagonal cut front panel allows easy access to contents. Closed on two sides to secure documents from falling out. Scored label placement marks on a double ply end-tab.

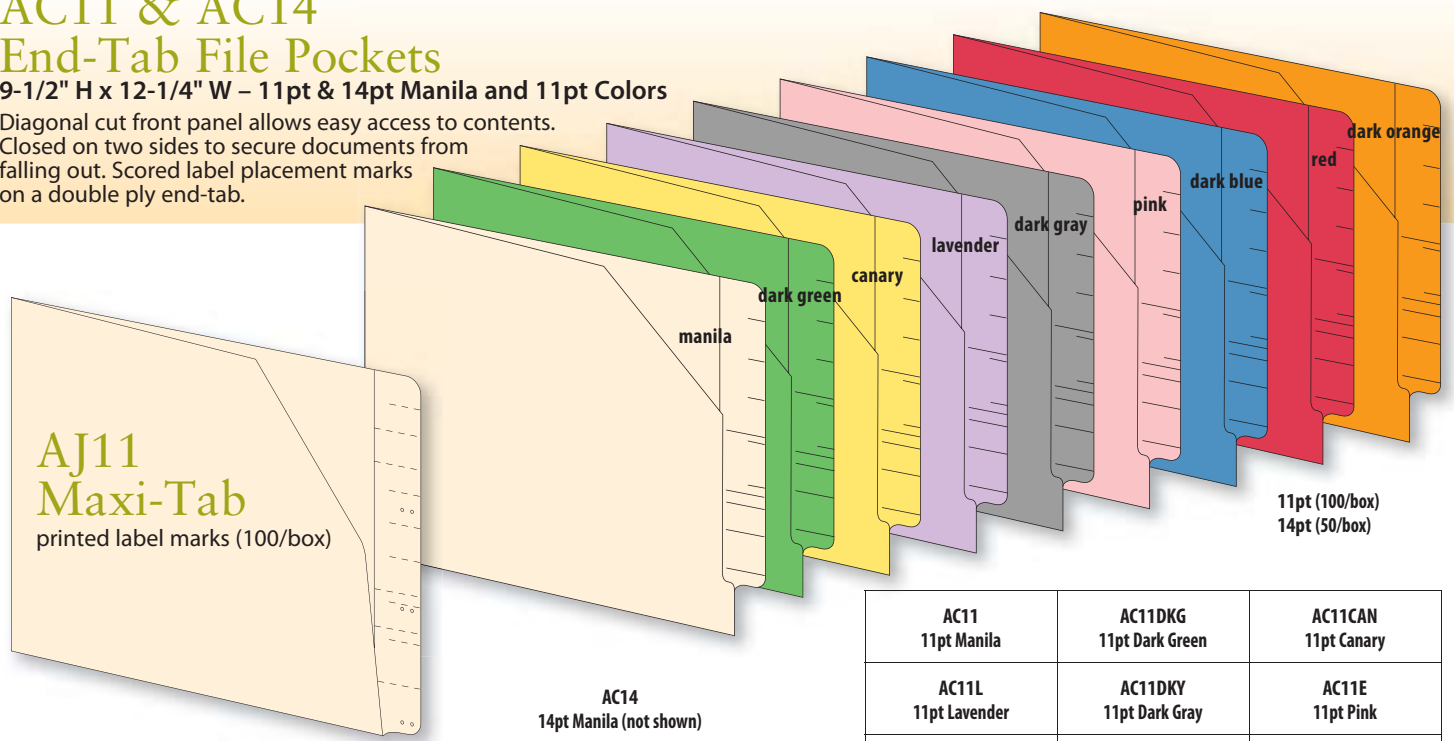

11pt (100/box)
14pt (50/box)

AC14
14pt Manila (not shown)

AC11 11pt Manila	AC11DKG 11pt Dark Green	AC11CAN 11pt Canary
AC11L 11pt Lavender	AC11DKY 11pt Dark Gray	AC11E 11pt Pink
AC11DKB 11pt Dark Blue	AC11D 11pt Red	AC11DKH 11pt Dark Orange

FP12 End-Tab File Pockets

9-1/2" H x 12-1/4" W
11pt Manila and Colors

Reinforced side seam construction with single ply top. Pockets are closed on three sides for maximum security and document protection.

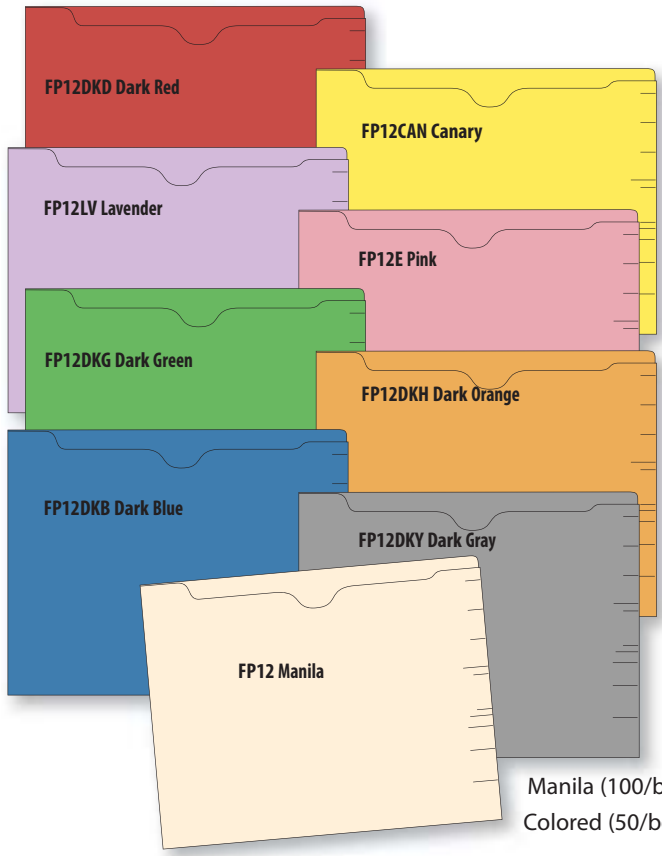

Manila (100/box)
Colored (50/box)

M11PK 11PT End-Tab Pockets

9-1/2" H x 12-1/4" W – Printed Color Border (100/Box)

More economical than colored stock, these manila pockets with printed borders have a double ply top and side for extra durability. Pockets have scored tab scores for easy label placement.



FP11 11PT Top Tab Pockets

9-1/2" H x 11-3/4" W – Manila and Colors

Double ply tab with double recessed thumb notch allows more space for labeling and provides easier access to contents. Perfect for drawer fling when quick color references are required. (100/box)

FP11DKD 11pt Dk Red	FP11DKG 11pt Dk Green	FP11L 11pt Lavender
FP11DKB 11pt Dk Blue	FP11CAN 11pt Canary	FP11DKY 11pt Dk Gray



MXP11 11 Point Expansion Pocket

9-1/2" H x 11-3/4" W – 9" H front

Double ply end tab with 1-1/2" paper gusset expansion. Ships tucked. (50/box)

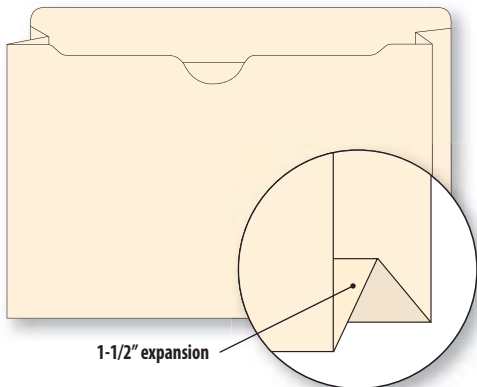

FPDT12 11 Point Manila Pocket

9-1/2" H x 12-1/4" W

Double ply end tab with thumbcut front and 8 scored tick marks. (100/box)

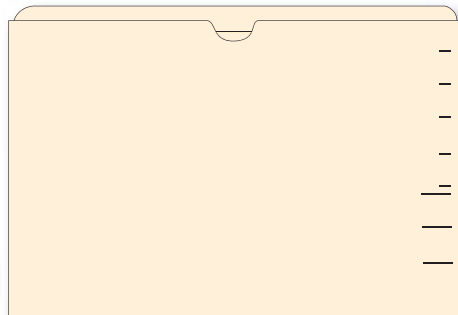

MJP11 11 Point Mini-End Tab

6" H x 9-1/2" W – Manila

Single ply end tab designed for optical office applications or small document storage. Closed on 2 sides. (100/box)

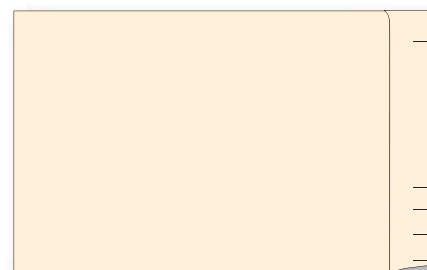

Economy File Envelopes

28 lb. and 32 lb. – Kraft Colors
8-3/4" H x 11-1/4" W

Perfect filing envelopes for lightly used files. Closed on three sides. Front is printed with spaces for name, home and business phone numbers plus addresses. (100/box)

28 lb. – All colors except Kraft and Gray

32 lb. – 1071K – Kraft
1073GY – Gray

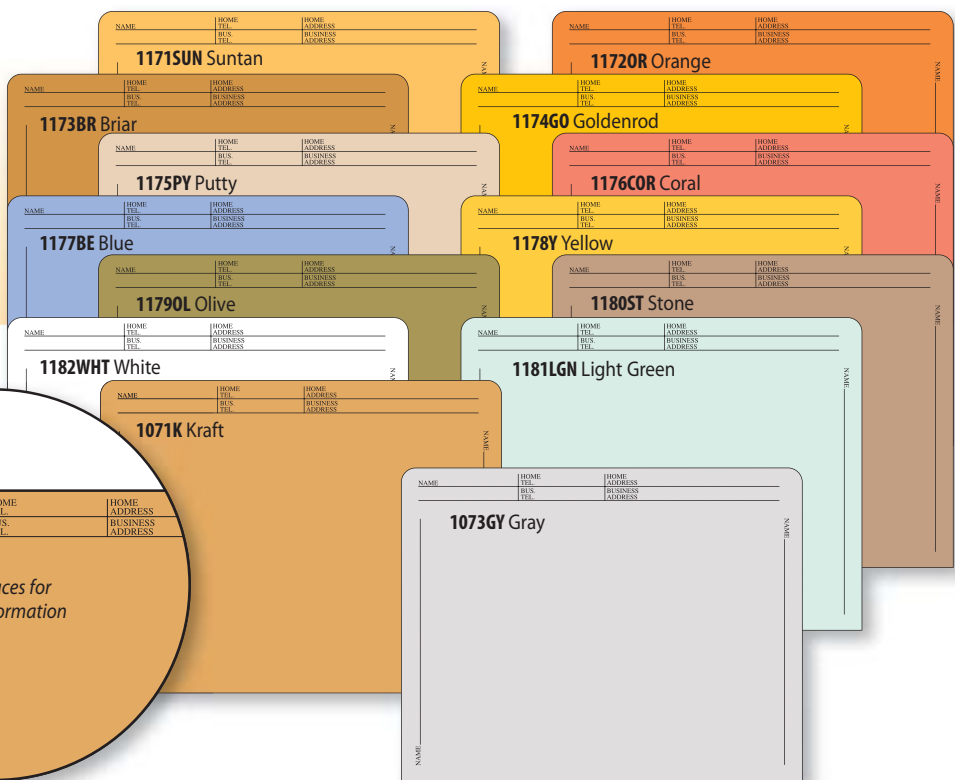

Kardex® Comparable Folders

Choose from a wide selection of folders constructed using only the highest quality pulp dyed colored stock and designed for use in the Kardex® 10 color system.



SEM-SCAN Numeric

Here's a highly effective terminal digit filing system that works great. It offers all the benefits of terminal digit filing with quick retrieval time.

SEM-SCAN Alpha

This system makes straight alphabetic filing obsolete. It dramatically cuts filing and retrieval time and practically eliminates misfiles. It works extremely well for any size filing system. It's simple to learn and set up.

SEM-SCAN Numeric

- 11pt Pulp Dyed Stock
- Overall Size: 9-1/2" X 11-3/4"
- Double-Ply Top & End Tab
- Scored for 3/4" expansion
- 0 - 9 scale printed on tab twice
- Available in 10 colors

SEM-SCAN Numeric Color Chart				
0 white	1 red	2 yellow	3 pink	4 green
5 brown	6 blue	7 orange	8 purple	9 tan

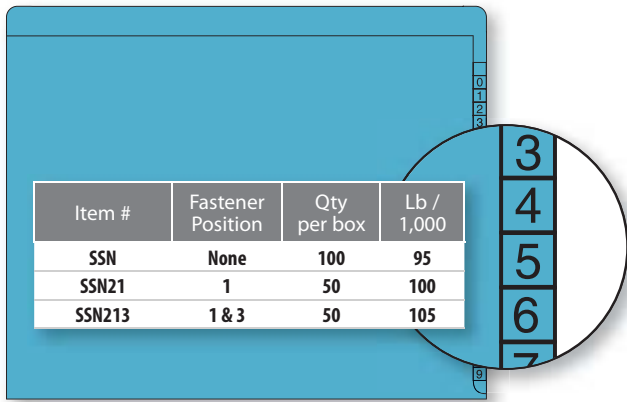

SEM-SCAN Alpha

- 11pt Pulp Dyed Stock
- Overall Size: 9-1/2" X 11-3/4"
- Double-Ply Top & End Tab
- Scored for 3/4" expansion
- A - Z scale printed on tab
- Available in 10 colors

SEM-SCAN Alpha Color Chart				
AB red	C yellow	DEF pink	GHI green	J white
KL brown	MNO blue	PQR orange	ST purple	U-Z tan

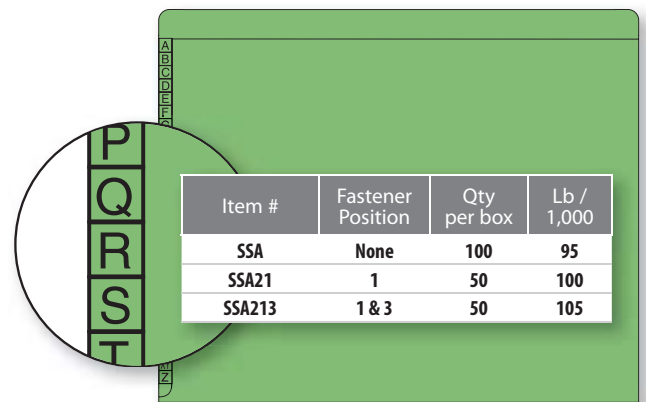

CT100

- 11pt Pulp Dyed Stock
- Overall Size: 9-1/2" X 11-3/4"
- Straight Cut 2-Ply Top Tab
- Available in 10 colors



white	blue
yellow	red
pink	green
orange	tan
brown	purple

Item #	Fastener Position	Qty per box	Lb / 1,000
CT100	None	100	95
CT10021	1	50	100
CT100213	1 & 3	50	105

SEM-SCAN 10

- 11pt Pulp Dyed Stock
- Overall Size: 9-1/2" X 12-1/4"
- Double-Ply Top & End Tab
- Scored for 3/4" expansion
- Available in 12 colors

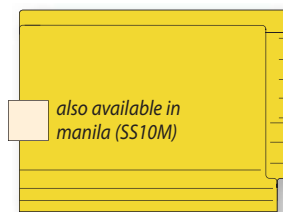

white	blue
yellow	red
dark blue	pink
green	orange
tan	brown
purple	gray

Item #	Fastener Position	Qty per box	Lb / 1,000
SS10	None	100	100
SS1021	1	50	105
SS10213	1 & 3	50	110

SEM-SCAN 20

- 20pt Pulp Dyed Stock
- Overall Size: 9-1/2" X 12-1/4"
- Single-Ply End Tab
- Scored for 3/4" expansion
- Available in 12 colors



white	blue
yellow	red
dark blue	pink
green	orange
tan	brown
purple	gray

Item #	Fastener Position	Qty per box	Lb / 1,000
SS20	None	40	150
SS2021	1	40	155
SS20213	1 & 3	40	160

SEM-SCAN 20T

9-1/2" x 12-1/4"

- 20pt Pulp Dyed Stock
- Single-Ply End Tab
- 1-1/2" Tyvek expansion
- Available in 12 colors

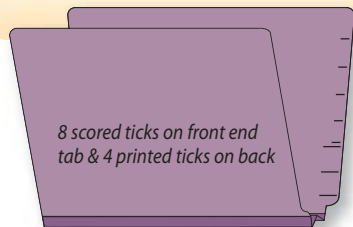

white	yellow	dark blue	green	tan	purple
blue	red	pink	orange	brown	DISCONTINUED

Item #	Paper Weight	Fastener Position	Qty per box	Lb / 1,000
SS20T	20pt	None	50	165
SS20T21	20pt	1	50	170
SS20T213	20pt	1 & 3	50	175

SEM-SCAN 20T Legal

9-1/2" x 15-1/4"

- 20pt Pulp Dyed Stock
- Single-Ply End Tab
- 1-1/2" Tyvek expansion
- Available in 12 colors



white	yellow	dark blue	green	tan	purple
blue	red	pink	orange	brown	DISCONTINUED

Item #	Paper Weight	Fastener Position	Qty per box	Lb / 1,000
SS20TL	20pt	None	50	200
SS20TL21	20pt	1	50	215
SS20TL213	20pt	1 & 3	50	220

SEM-SCAN 20T Numeric

9-1/2" x 12-1/4"

- 20pt Pulp Dyed Stock
- Single-Ply End Tab
- 1-1/2" Tyvek expansion
- 0 - 9 scale printed on tab
- Available in 10 colors

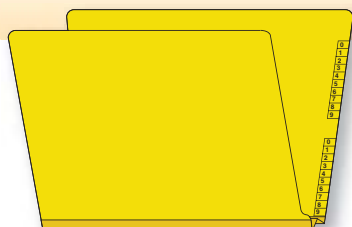

white	red	yellow	pink	green
brown	blue	orange	purple	tan

Item #	Paper Weight	Fastener Position	Qty per box	Lb / 1,000
SS20TN	20pt	None	50	165
SS20TN21	20pt	1	50	170
SS20TN213	20pt	1 & 3	50	175

SEM-SCAN 20T Numeric Legal

9-1/2" x 14-3/4"

- 20pt Pulp Dyed Stock
- Single-Ply End Tab
- 1-1/2" Tyvek expansion
- 0 - 9 scale printed on tab
- Available in 10 colors

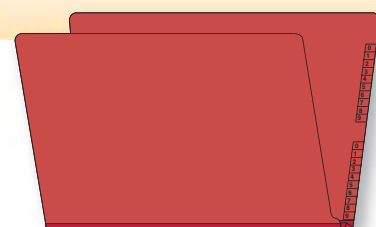

white	red	yellow	pink	green
brown	blue	orange	purple	tan

Item #	Paper Weight	Fastener Position	Qty per box	Lb / 1,000
SS20TNL	20pt	None	50	200
SS20TNL21	20pt	1	50	215
SS20TNL213	20pt	1 & 3	50	220

SEM-SCAN 20T Alpha

9-1/2" x 12-1/4"

- 20pt Pulp Dyed Stock
- Single-Ply End Tab
- 1-1/2" Tyvek expansion
- A - Z scale printed on tab
- Available in 10 colors



red	yellow	pink	green	white
brown	blue	orange	purple	tan

Item #	Paper Weight	Fastener Position	Qty per box	Lb / 1,000
SS20TA	20pt	None	50	165
SS20TA21	20pt	1	50	170
SS20TA213	20pt	1 & 3	50	175

SEM-SCAN 20T Alpha Legal

9-1/2" x 14-3/4"

- 20pt Pulp Dyed Stock
- Single-Ply End Tab
- 1-1/2" Tyvek expansion
- A - Z scale printed on tab
- Available in 10 colors

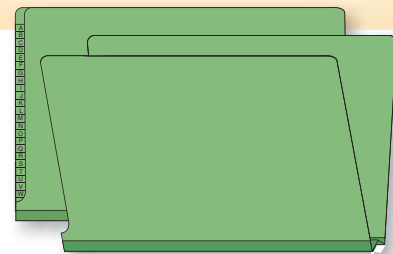

red	yellow	pink	green	white
brown	blue	orange	purple	tan

Item #	Paper Weight	Fastener Position	Qty per box	Lb / 1,000
SS20TAL	20pt	None	50	200
SS20TAL21	20pt	1	50	215
SS20TAL213	20pt	1 & 3	50	220

Folder Pockets

Manila & Kraft Pockets

Stock No.	Description	Size	Pack
DP11	11pt Manila Double Pocket	Back: 8-1/2" x 9" and Front: 5" x 9"	100/Carton
4024	11pt Manila Single Pocket	Overall Size: 5" x 8-3/4"	100/Carton
4021	11pt Manila Single Pocket	Overall Size: 5" x 9-1/4"	100/Carton
FE69T	32lb Kraft Envelope	Overall Size: 9" x 6"	100/Carton
FE96S	32lb Kraft Envelope	Overall Size: 6" x 9"	100/Carton
FE85	28lb Kraft Envelope	Overall Size: 5" x 8-1/8"	100/Carton
FE64	28lb Kraft Envelope	Overall Size: 4" x 6-1/8"	100/Carton

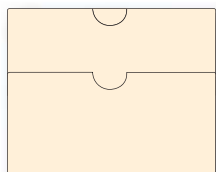
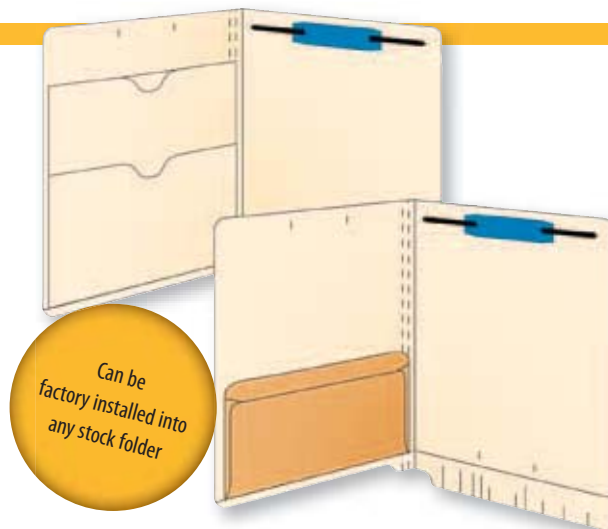

DP11

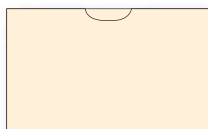

4024

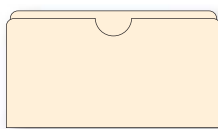

4021



FE85

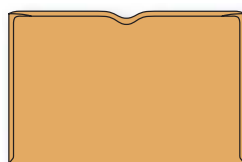

FE96S



FE64

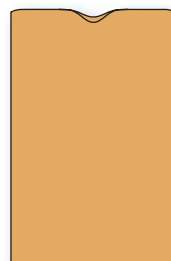

FE69T

XR35

2-1/4" H x 3-1/2" W
Dental x-ray envelope to store bite plates. (500 / box)

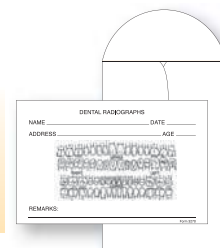

Self-Adhesive 11pt Manila Pockets

Whenever you need to add a pocket or fill in while factory is installing your order these are a great solution.

SAP8555: 8-3/4" W x 5-1/2" H
SAP1175: 11-1/2" W x 7-1/2" H



Unique single ply construction with self-adhesive flaps creates less bulk



Fold edges under, peel off backing and adhere to folder.

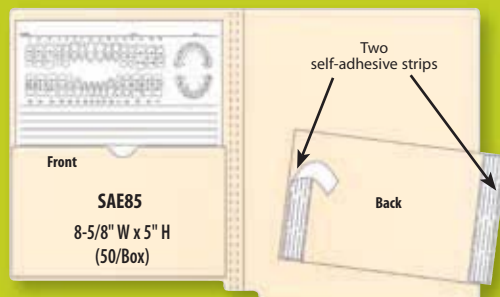

11pt manila single pocket

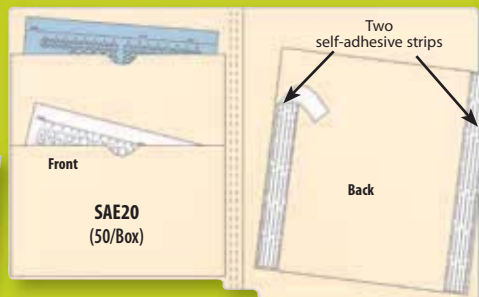

11pt manila double pocket

Back pocket: 9" W x 8-1/2" H
Front pocket: 9" W x 5" H

Folder Pockets

Self-adhesive Vinyl and Poly Pockets

Choose from several sizes of poly pockets to fit your needs. Ideal for:

- Lab reports
- Film
- ID cards
- Phone messages
- Script duplicates
- Any small document

Peel off the backing paper and apply to your patient charts or wherever it is most convenient for your use.

6 Mil Vinyl

Pockets are heavy-duty vinyl that resists punctures and tears

5 Mil Poly

Pockets are an economical choice for storing loose items like notes, X-rays, etc.



First Dimension is the side which is open.

Stock No. Overall Size Inside Dimension

5 Mil Poly Pockets

7200S	2 ⁵ / ₈ " x 4 ¹ / ₁₆ "	2 ¹ / ₈ " x 3 ¹ / ₄ "
7205S	2 ³ / ₄ " x 3 ⁵ / ₈ "	2 ³ / ₈ " x 2 ¹⁵ / ₁₆ "
7210S	3 ¹ / ₈ " x 4"	2 ¹ / ₂ " x 3 ¹ / ₄ "
7230S	4 ¹ / ₄ " x 8"	3 ³ / ₄ " x 7 ¹ / ₄ "
7220S	4 ¹ / ₂ " x 5 ⁹ / ₁₆ "	4 ¹ / ₈ " x 4 ³ / ₄ "
7240S	5" x 7 ¹ / ₄ "	4 ¹ / ₂ " x 6 ¹ / ₂ "
7215S	5 ¹ / ₂ " x 3 ¹ / ₄ "	5" x 2 ¹ / ₂ "
7225S	5 ³ / ₄ " x 3 ³ / ₄ "	5 ³ / ₁₆ " x 3"
PD64	7" x 5"	6 ¹ / ₂ " x 4 ¹ / ₄ "
7250S	9 ¹ / ₄ " x 6"	8 ³ / ₄ " x 5 ¹ / ₄ "
7260S	11" x 8 ³ / ₄ "	10 ¹ / ₂ " x 8"
7255S	11 ¹ / ₁₆ " x 9 ⁵ / ₁₆ "	10 ³ / ₄ " x 8 ³ / ₄ "

6 Mil Vinyl Pockets

VP53SA	5 ³ / ₈ " x 3 ⁵ / ₈ "	5 ¹ / ₈ " x 3"
VP64SA	6 ³ / ₈ " x 4 ¹ / ₂ "	6 ¹ / ₂ " x 3 ⁷ / ₈ "
VP85SA	9" x 5 ¹ / ₂ "	8 ¹ / ₂ " x 4 ³ / ₄ "

Lock-It Pockets (self-adhesive)

LP610SA: 6-1/2" W x 10" H

LP56SA: 5-1/2" W x 6-1/4" H

Durable, clear polyethylene ziplock style secures small documents including X-rays, photos, diskettes, CDs and more (100/Box)



Zip-It Pockets

Secure single track closures keep out dirt and moisture. 2 mil thick and allows visual observation (100/Box)

Stock No.	Description	Size
ZIP23	Clear Front	Overall Size: 2" x 3"
ZIP34	Clear Front	Overall Size: 3" x 4"
ZIP35	Clear Front	Overall Size: 3" x 5"
ZIPW23	Writable Front	Overall Size: 2" x 3"
ZIPW35	Writable Front	Overall Size: 3" x 5"
ZIPW46	Writable Front	Overall Size: 4" x 6"



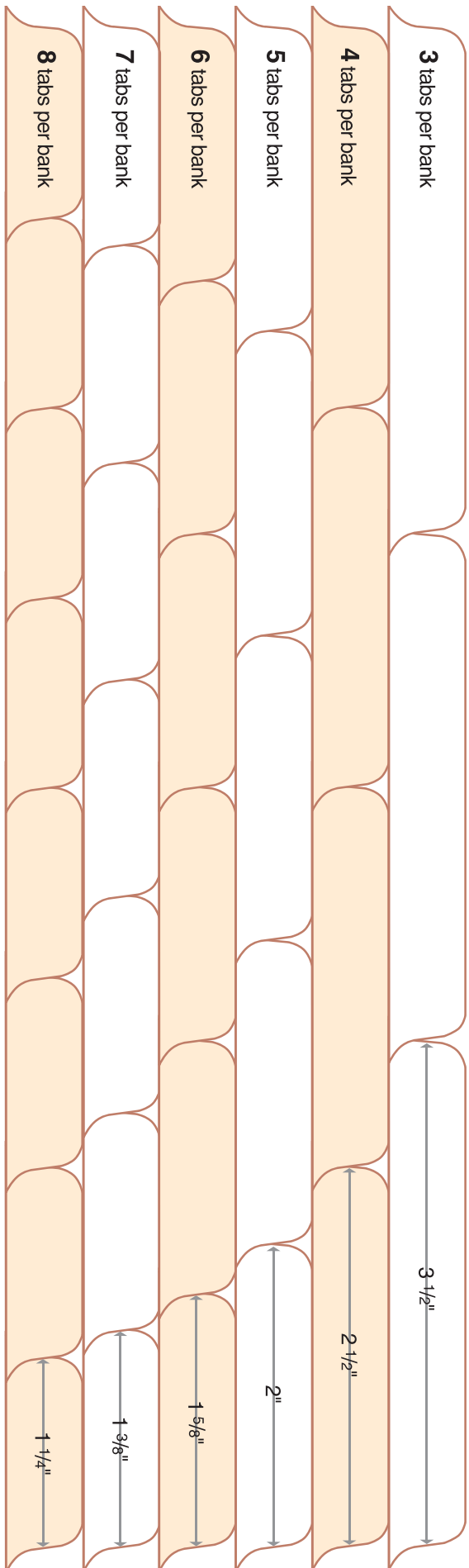

Position #1 starts at the top. Tabs shown actual size. (Plan ahead! Consider leaving an empty position for future use.)

Easy Ordering Instructions

- 1 Choose the style of Chart Divider and Paper Color
 - Index Style A-E and Stock Color
 - Fileback Style I-III
 - Self-Adhesive Fileback Style - SA
- 2 Specify tab cut size. See charts at left and below right. (Plan ahead! Consider leaving an empty position for future use.)
- 3 Specify each tab title (text), position and color. (Side tab styles start at the top and bottom tab styles start at the left.)
- 4 Specify packaging:
 - Collated - Titles boxed together in sets (File-backs are loose, not attached to each other)
 - Not collated - Titles boxed individually



INDEX/CHART DIVIDERS/STYLES A-E

- 90 lb. or 110 lb. White or Ivory Stock
- Mylar Reinforced Punches
- Tabs Printed Both Sides/Mylar Covered
- 8-1/2" x 11"+ (Side Tabs - 1/2" — Bottom Tabs - 3/8" or 1/2")



SELF-ADHESIVE FILEBACKS/STYLE SA

- 110 lb. Ivory Index (Manila) Stock
- 1" Scored Hinge With 3/4" Pressure Sensitive Tape
- Two Pre-installed 2" Bonded Fasteners (1 Each Side)
- Tabs Print Both Sides w/Different Titles/Mylar Covered
- 8-1/2" x 11"+ (Side Tabs - 1/2")

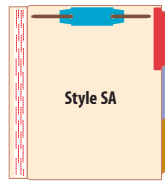

FLIP UP HINGED FILEBACKS/STYLES I-III

- 110 lb. Ivory Index (Manila) Stock
- 1" Scored Hinge With Mylar Reinforced Slits
- One Pre-installed 2" Bonded Fastener
- Tabs Print Both Sides/Mylar Covered
- 8 1/2" x 11"+ (Side Tabs - 1/2" – Bottom Tabs - 3/8" or 1/2")

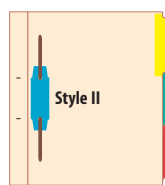
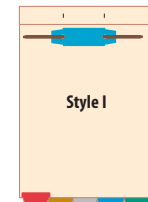

General specifications are listed above. Contact your local sales representative for other options including: body printing, collating, assembly and installation; heavier paper weights and colors, etc.

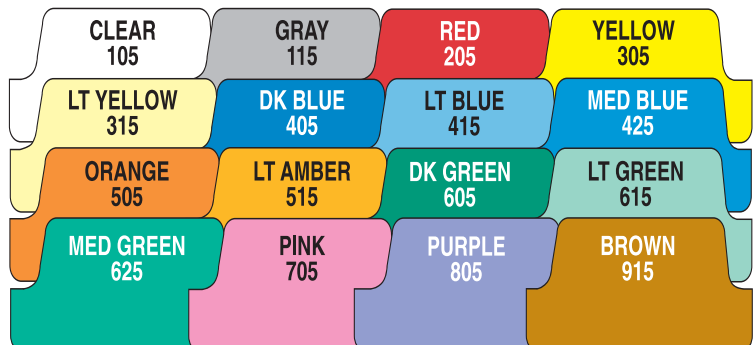

16 STANDARD MYLAR TAB COLORS

Neon colors available for an additional charge.

PROVEN SOLUTIONS

Use One or All Three Styles of Dividers for Active Patient Record Organization



Bottom and Side Tab Indexes Used With Self-Adhesive Filebacks

Maximize and divide without excessive bulk. These three styles of dividers used in conjunction with each other can provide over 20 sections in a standard folder with 3/4" expansion. Center section without fasteners allows for convenient drop-in filing.



Dividers and Pockets Make a Perfect Chart

Small documents, papers you can't punch, active patient visits and archived information all in one chart... that's creative and efficient. For Pressure Sensitive Pockets see pages 25.

Multi-Functional Solutions Help Organize Contents of Patient Records

Use one or all three styles of chart dividers to maximize document organization. Proven to provide a uniform and consistent method to categorize information, each style provides unique benefits.

INDEXES – The most common, economical style provides for multiple categories without excessive bulking in file.

FILEBACKS – Hinged/piggy-back style allows greater flexibility because each category can be utilized individually.

SELF-ADHESIVE DOUBLE DUTY FILEBACKS – Provide the same number of categories with just one half the amount of dividers because the tabs have a different title printed on each side. If ordered with a fastener installed on the front only, they can provide sections for quick, drop-in filing.

Combine the benefits of all three to create the patient chart that works best for you.



A Great Solution for Very Active Records

Docuclip fasteners (page 23) used in conjunction with standard book style/side tab indexes provide maximum access and flexibility to all patient information. Proven to be a real workhorse.



Combine Indexes and Filebacks Based on Document Activity

Indexes can be used to divide and categorize documents which have minimal activity or do not require active additions to each section. Filebacks used in conjunction with indexes allow more active use of sections within the chart.



Two Styles of Filebacks Eliminates Folder Distortion

Using both flip-up style and book style filebacks provides for equalization of contents within the record. Also eliminates excessive bulking at one end of folder which allows easier filing and retrieval.

Position #1 starts at the left. Tabs are shown actual size. (Plan ahead! Consider leaving an empty position for future use or add a writeable mylar tab to the end of the set.)

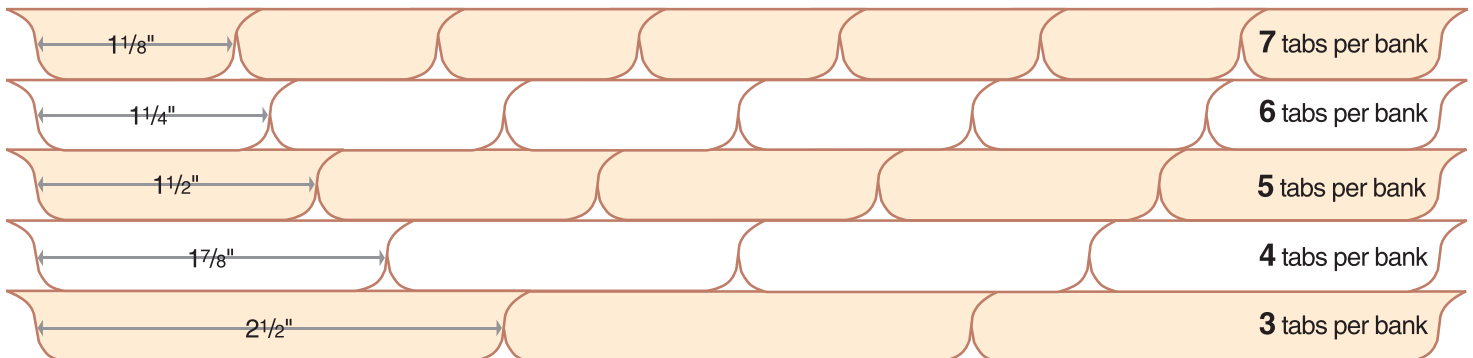

Stock Index Chart Dividers

Stock Bottom Tab Collated Sets

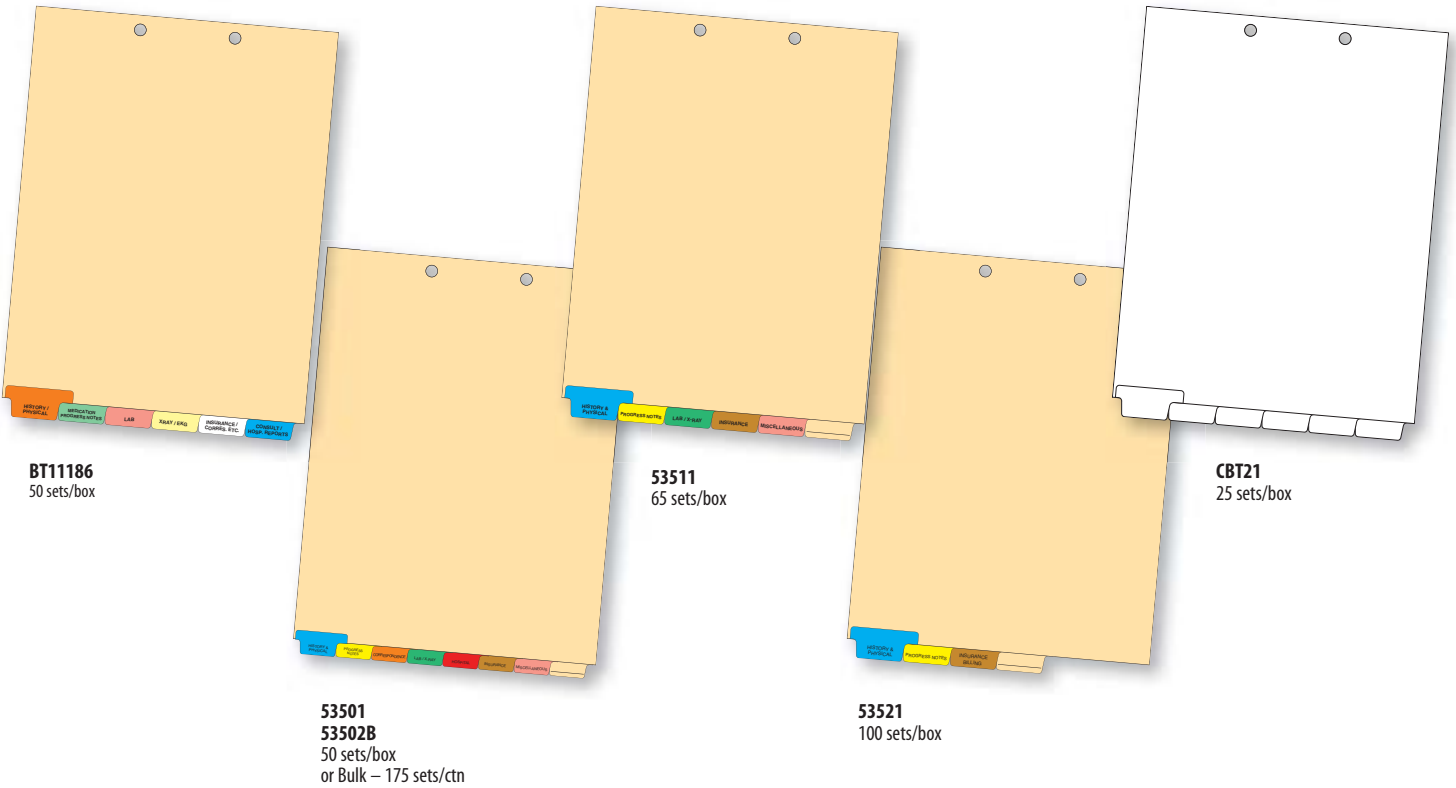

Stock Side Tab Collated Sets

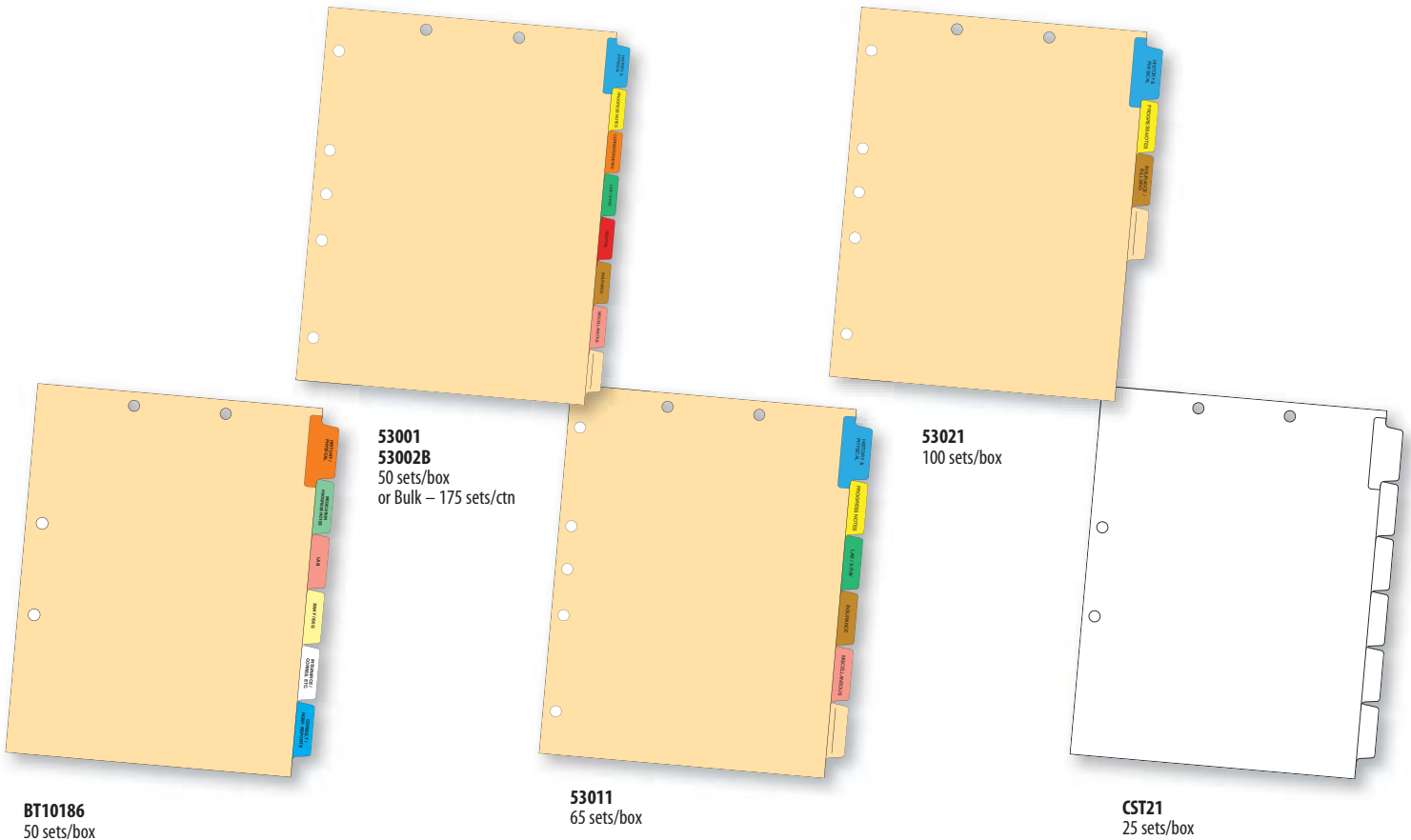

Stock Index Chart Dividers

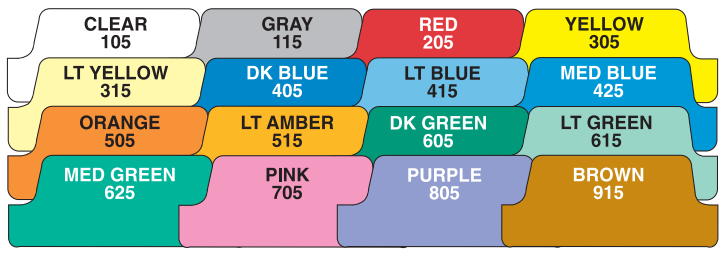

Bottom Tab

BOTTOM TAB STYLE WITH TITLES
1/6 CUT – PUNCHED TOP



TAB POSITION 1

- History/Physical
52100 ■ Orange
- Immunizations/Injections
52102 ■ Orange
- Lab/Special Reports
52103 ■ Lt. Green
- Paps & Colposcopy
52109 ■ Orange
- Patient Information
52108 ■ Med. Blue
- Progress Notes
52107 ■ Orange

TAB POSITION 2

- Consents
52209 ■ Yellow
- Correspondence
*52204 ■ Lt. Yellow
- Diagnostic Testing
52207 ■ Med. Green
- History/Physical
52203 ■ Pink
- Lab
52211 ■ Lt. Green
- Medication/Progress Notes
52200 ■ Lt. Green
- Prescriptions
52208 ■ Red
- Progress Notes
52201 ■ Lt. Green
- Surgery
52202 ■ Lt. Green
- X-Rays/Scans
52212 ■ Lt. Amber

TAB POSITION 3

- Lab
52300 ■ Pink
- Operative Reports
52302 ■ Med. Blue
- Physical Therapy
52308 ■ Pink
- Physicians Orders
52306 ■ Lt. Amber
- Procedures
52310 ■ Lt. Amber
- Special Studies
52307 ■ Med. Blue

TAB POSITION 4

- Imaging
52408 ■ Gray
- Miscellaneous
52404 ■ Lt. Green
- Nurses Notes
52406 ■ Gray
- Pathology
52407 ■ Brown
- X-Ray
52409 ■ Gray
- X-Ray/EKG
52400 ■ Lt. Yellow

TAB POSITION 5

- Authorization/Referrals
52502 Clear
- Correspondence
52508 Clear
- EKG
52504 ■ Red
- Insur./Corres., Etc.
52500 Clear
- Letters
52512 Clear
- Miscellaneous
52501 Clear
- Sonogram/Ultrasound
52513 ■ Red
- Telephone Messages
52503 ■ Lt. Yellow

TAB POSITION 6

- Consultation
52612 ■ Red
- Consultation/Hosp. Reports
52600 ■ Med. Blue
- Correspondence
52604 ■ Med. Blue
- Flow Sheets
52608 ■ Gray
- Hospital Records
52618 Clear
- Insurance
52609 ■ Med. Blue
- Medical Records
52606 ■ Med. Blue



Side Tab

SIDE TAB STYLE WITH TITLES
INTERCHANGABLE RIGHT/LEFT SIDE 1/6 CUT – PUNCHED TOP AND SIDE

TAB POSITION 1

- History/Physical
51103 ■ Orange
- Immunizations/Injections
51110 ■ Orange
- Lab/Special Reports
51105 ■ Lt. Green
- Paps & Colposcopy
51101 ■ Orange
- Patient Info
51109 ■ Med. Blue
- Progress Notes
51108 ■ Orange

TAB POSITION 2

- Correspondence
51204 ■ Lt. Yellow
- Diagnostic Testing
51201 ■ Lt. Green
- Hospital Records
51202 ■ Lt. Green
- Lab
51208 ■ Lt. Green
- Medication/Progress
51202 ■ Lt. Green
- Prescriptions
51206 ■ Red
- Progress Notes
51203 ■ Lt. Green
- Surgery
51205 ■ Lt. Green
- X-Rays/Scans
51209 ■ Lt. Amber

TAB POSITION 3

- Audiograms
51302 ■ Pink
- Lab
51300 ■ Pink
- Operative Reports
51303 ■ Med. Blue
- Physicians Orders
51307 ■ Lt. Amber
- Procedures
51310 ■ Lt. Amber
- Special Studies
51308 ■ Med. Blue

TAB POSITION 4

- Allergy
51402 ■ Lt. Yellow
- Miscellaneous
51406 ■ Lt. Green
- Pathology
51401 ■ Brown
- Therapy
51403 ■ Purple
- X-Ray
51408 ■ Gray
- X-Ray/EKG
51400 ■ Lt. Yellow

TAB POSITION 5

- Authorization/Referrals
51520 Clear
- Correspondence
51510 Clear
- EKG
51504 ■ Red
- Financial
51506 ■ Lt. Green
- Insurance/Correspondence
51500 Clear
- Mammography
51502 ■ Purple
- Miscellaneous
51501 Clear
- Radiology
51505 ■ Red
- Telephone Messages
51503 ■ Lt. Yellow

TAB POSITION 6

- Consultation
51618 ■ Red
- Consult./Hosp. Reports
51604 ■ Med. Blue
- Correspondence
51606 ■ Med. Blue
- Hospital Records
51614 Clear
- Insurance
51602 ■ Med. Blue
- Medical Records
51603 ■ Med. Blue
- OB Records
51600 ■ Lt. Amber
- Other
51607 ■ Orange
- Previous Medical Records
51601 ■ Gray

Self-Adhesive Dividers and Filebacks

Self-Adhesive Dividers and Filebacks Help Organize

Divide the contents of your folders to better organize documents. Easy to install. Use more than one style together in a folder. All dividers are made from 11pt manila stock and have a 7/8" flap with self-adhesive tape. Die-cuts on flaps allow positioning around fasteners.

Folders sold separately

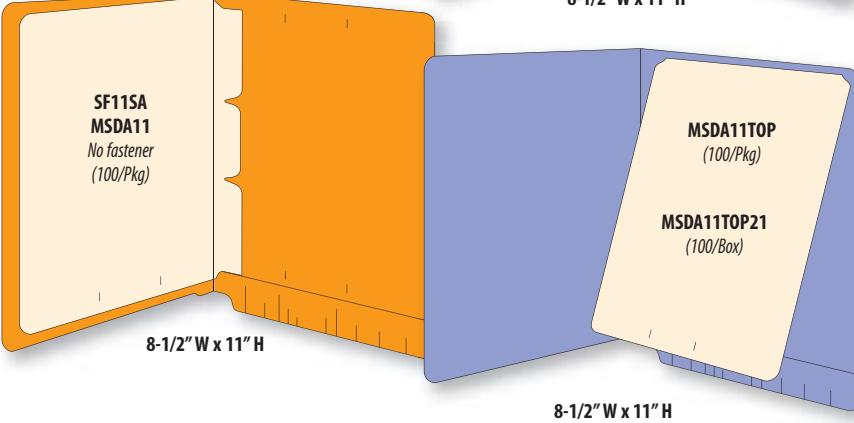
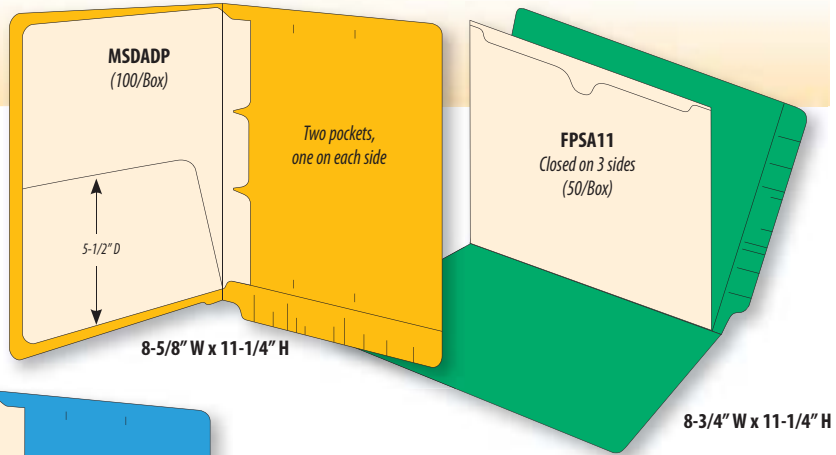

All sizes do not include 7/8" flap

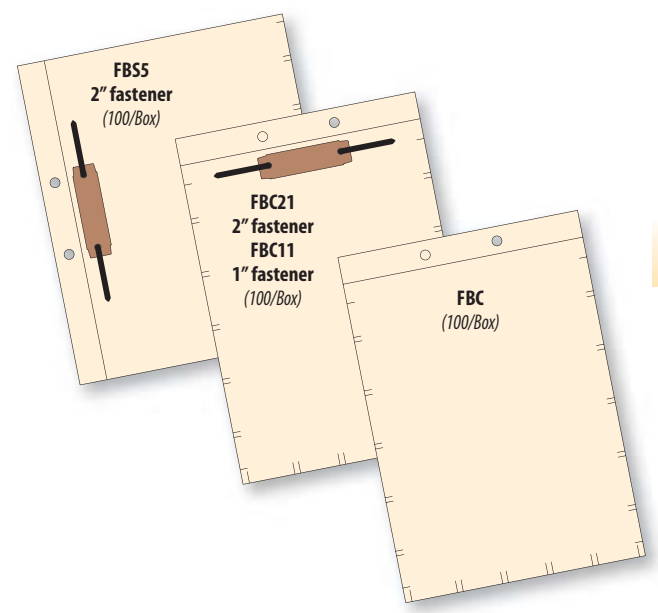
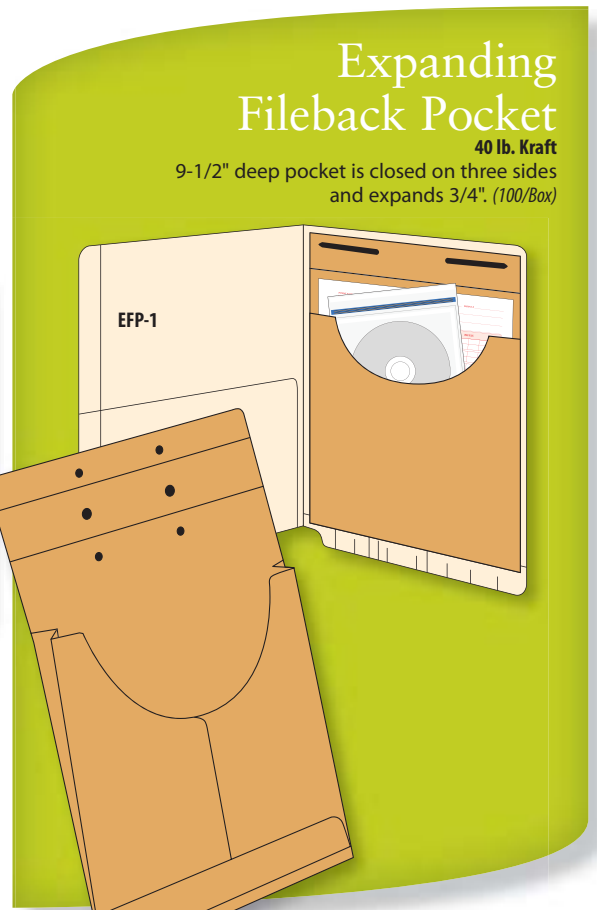

Fileback Dividers

- Add or remove sheets without tearing apart files
 - Choose end or side fastener dividers
- Now get immediate access to each section without removing top sections from the chart. Just fold on score line to form flap and slip divider over existing fastener in folder. The next divider is attached to the fastener on the first divider, and so on. Sturdy 11pt manila stock.